

TRINGLES À RIDEAUX À TIRAGE CORDON

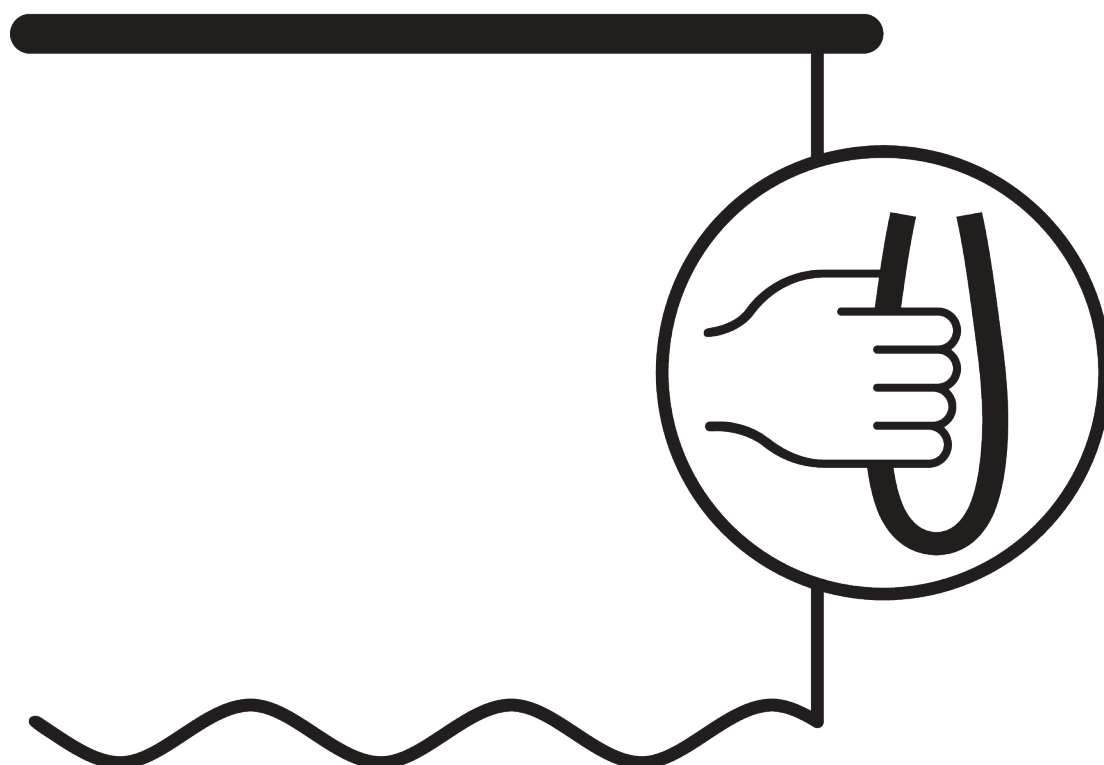

INFORMATIONS GÉNÉRALES

Dimensions

- Mesures en mm sauf indication contraire.
- Le poids maxi inclus le tissu et les accessoires.
- La taille du paquet rideau dépend de la confection et de l'épaisseur du tissu.
- Distance maxi entre glisseurs 80 mm / Distance maxi entre rouleurs 100 mm.
- Ecart recommandé entre bas du rideau et le sol: 20 mm.
- Pour déterminer la hauteur du système (B), la hauteur la plus petite doit être prise en compte.
- Le fonctionnement de l'ensemble peut être affecté si le rideau touche le profil.



Installation

- Installation par poseur qualifié.
- Nombre de supports et points de fixation dépendent du poids du tissu, de la surface de pose, des vis utilisées et des obstacles.
- Les poseurs doivent utiliser les fixations appropriées à chaque situation.
- La lèvres du profil si elle existe doit être installée vers l'intérieur pièce.

Sécurité enfant

- Tous les systèmes Silent Gliss concernés répondent à la norme sécurité EN 13120.
- Tous les intervenants doivent être en conformité avec la norme EN 13120.

GUIDE D'UTILISATION

<u>PAGE</u>	<u>SYSTÈME</u>	<u>MODE DE COMMANDE</u>	<u>DIMENSION</u>	<u>DESIGN</u>	<u>WAVE</u>	← max. →	kg _{max.}
5	SG 1014		S			6 m	11 kg
9	SG 3840		M - L			6 m	14 kg
21	SG 3870		M - L			6 m	14 kg
33	SG 3900		M - L			12 m	20 kg
39	SG 3970		M - L			15 m	38 kg
49	SG 6370		L			15 m	66 kg

SG 1014

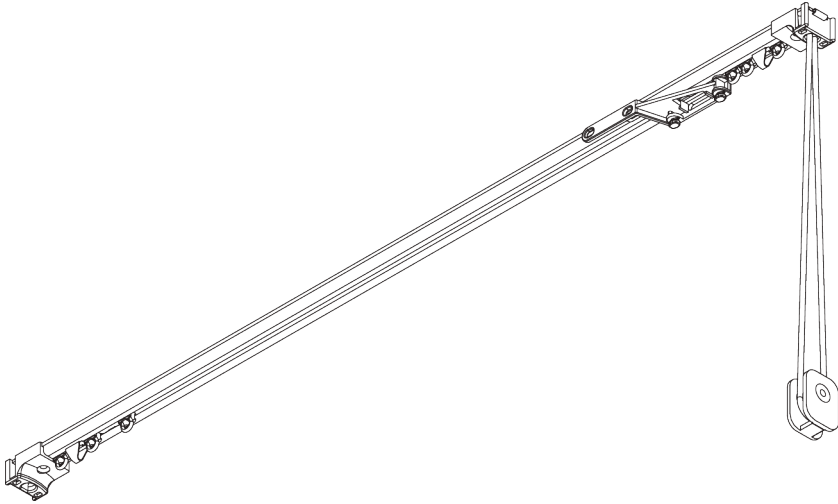
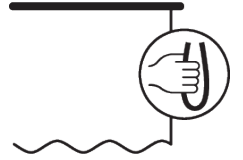

INFORMATION PRODUIT

- **Mode de commande:** Tirage cordon
- **Gamme:** S
- **Installation:** Plafond
- **Couleurs:** Blanc RAL 9016 ou Aluminium, couleurs spéciales possibles
- **Tissus:** Se référer à la collection tissu Silent Gliss

Caractéristiques:

- Profil prépercé
- Cintrable
- Outil d'installation SG 7550

SPÉCIFICATION SYSTÈME

A. DIMENSIONS SYSTÈME

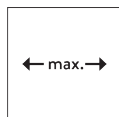

6 m

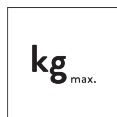

11 kg

Poids maximum du rideau

	2 m	4 m	6 m
	8	7	6
	11	10	8
	5	4	-
	6	5	-
	3	2	-
	5	4	-

(kg max.)

B. PROFIL

Profil et information de cintrage

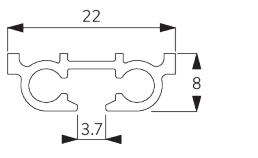

SG 1014p

Profil

✓ Rayon: 20 cm

C. PRISE DE MESURE

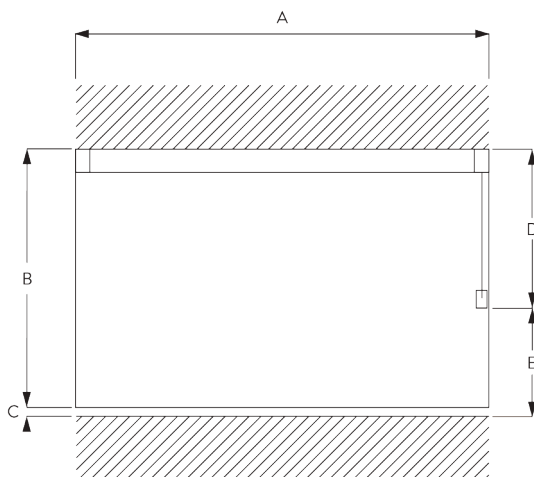

A: Largeur système

B: Hauteur système

C: Distance entre bas du rideau et le sol

D: Hauteur corde

E: Sécurité SG 10731. min. 150 cm du sol

INSTALLATION

A. INSTRUCTION DE POSE

Pour des informations détaillées, se référer au site web Silent Gliss.

Points de fixation

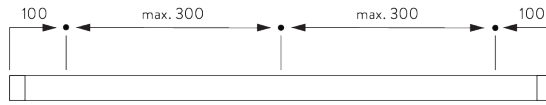

Outils d'installation

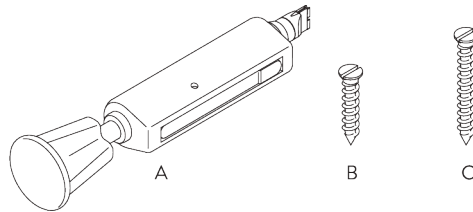

A: Outil Center SG 7550 Tool

B: Vis SG 3019 / 12 mm

C: Vis SG 3025 / 18 mm

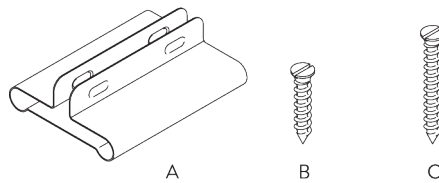

A: Outil de protection du profil SG 7002

B: Vis SG 3019 / 12 mm

C: Vis SG 3025 / 18 mm

B. FIXATION PLAFOND

Fixation directe dans le bois

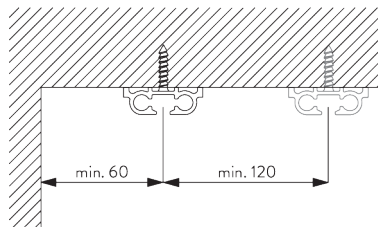

Support SG 3114

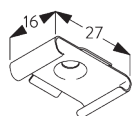
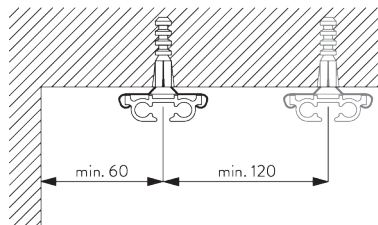

SG 3114

Support plafond

ACCESSOIRES

A. ACCESSOIRES STANDARDS

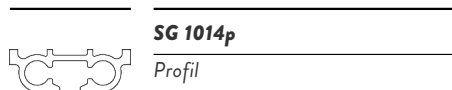

SG 1014p

Profil

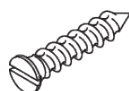

SG 3019

Vis à bois 12 mm



SG 3030

Conducteur

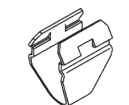

SG 3085

Ressort d'arrêt



SG 3090

Corde ø 3.5 mm

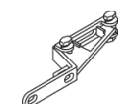

SG 3242

Chariot croisant



SG 3533

Glisseur

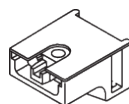

SG 3714

Poulie



SG 10731

Poulie de sécurité pour chaîne & cordon

B. ACCESSOIRES EN OPTION

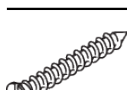

SG 3025

Vis à bois 18 mm

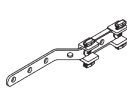

SG 3045

Chariot croisant



SG 3070

Fixateur avec œillet



SG 3114

Support plafond



SG 3340

Contrepoids



SG 3534

Glisseur 3533 en barrette de 20 unités



SG 3582

Agrafe Delrin



SG 3735

Tendeur

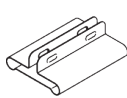

SG 7002

Protecteur de profil

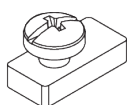

SG 11335

Arrêt

SG 3840

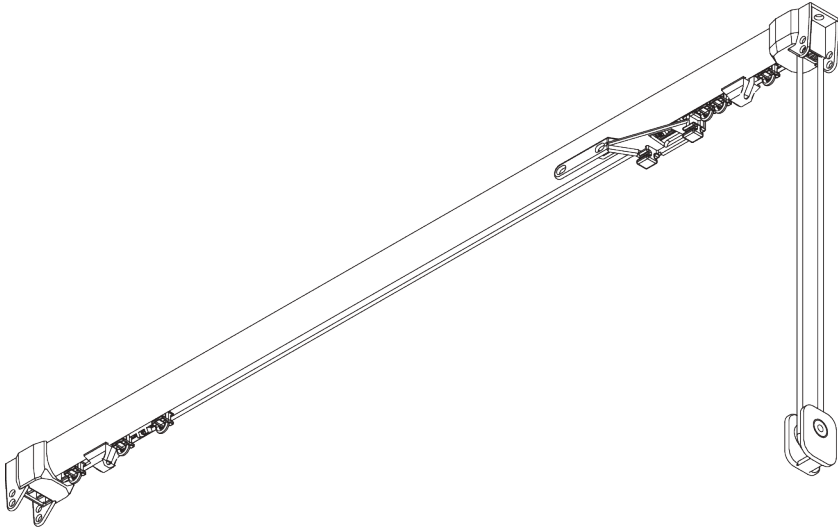
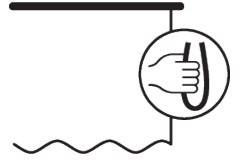

INFORMATION PRODUIT

- **Mode de commande:** Tirage cordon
- **Gamme:** M - L
- **Installation:** Plafond, murale
- **Couleurs:** Blanc RAL 9016, Noir RAL 9005 ou Aluminium, couleurs spéciales possibles
- **Tissus:** Se référer à la collection tissu Silent Gliss

Caractéristiques:

- Glisseurs bi-composants
- Option Wave Glisseur bi-composants
- Cintrable

SPÉCIFICATION SYSTÈME

A. DIMENSIONS SYSTÈME



6 m

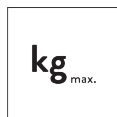

14 kg

Poids maximum du rideau avec glisseur bi-composants ou rouleur

	2 m	4 m	6 m
	12	11	10
	14	13	12
	9	8	7
	10	9	6
	6	5	4
	7	6	5
	5	4	3
	6	5	4

(kg max.)

Poids maximum du rideau avec glisseur Wave bi-composants

	2 m	4 m	6 m
	5	8	7
	5	8	8
	5	6	5
	5	6	6
	4	3	-
	4	4	3
	3	2	-
	3	3	-

(kg max.)

B. PROFIL

Profil et information de cintrage

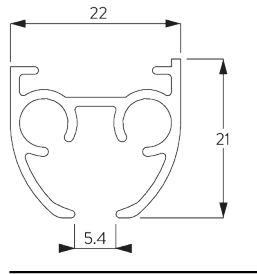

SG 3841

Profil

Rayon:
20 cm, >30 cm

C. PRISE DE MESURE

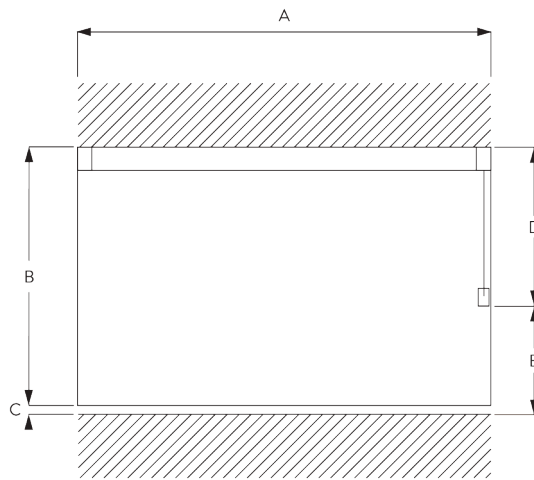

A: Largeur système

B: Hauteur système

C: Distance entre bas du rideau et le sol

D: Hauteur corde

E: Sécurité SG 10731. min. 150 cm du sol

INSTALLATION

A. INSTRUCTION DE POSE

Pour des informations détaillées, se référer au site web Silent Gliss.

Points de fixation

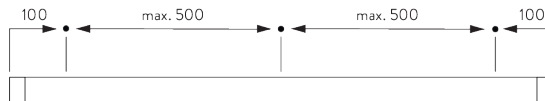

B. FIXATION PLAFOND

Bride SG 3825

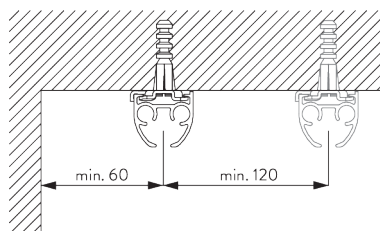

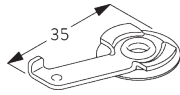

SG 3825

Bride

Support SG 3832

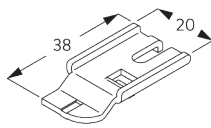
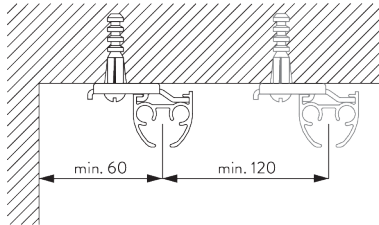

SG 3832

Support

Support SG 3826

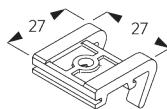
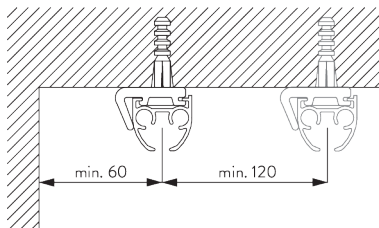

SG 3826

Support

C. FIXATION

MURALE

Smart Fix

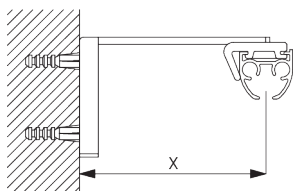

Smart Fix SG 11200 - SG 11205 et support SG 3826:
Vis SG 10492 (M4x8) nécessaire.

Smart Fix	X mm (SG 3826 / SG 3825)	X mm (SG 3832)
SG 11200 / SG 11210	52	70
SG 11201 / SG 11211	72	90
SG 11202 / SG 11212	92	110
SG 11203 / SG 11213	112	130
SG 11204 / SG 11214	142	160
SG 11205 / SG 11215	192	210
SG 11154	102 - 130	120 - 148
SG 11155	132 - 160	150 - 178
SG 11156	182 - 210	200 - 228

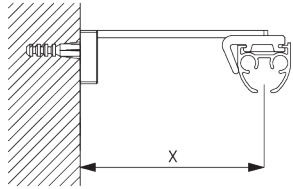

**Square Smart Fix SG 11210 - SG 11215
et support SG 3826:**
Vis SG 10492 (M4x8) nécessaire.

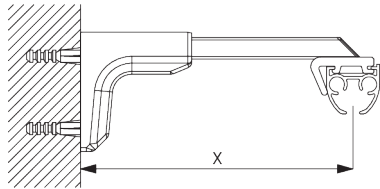

**Universal Smart Fix SG 11154 - SG 11156
et support SG 3826:**
Vis SG 10277 (M4x12) nécessaire.

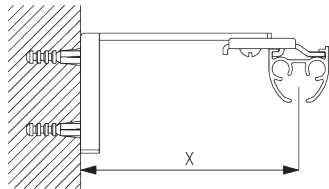

Smart Fix SG 11200 - SG 11205 et support SG 3832:
Vis SG 10492 (M4x8) nécessaire.

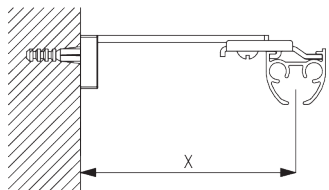

**Square Smart Fix SG 11210 - SG 11215
et support SG 3832:**
Vis SG 10492 (M4x8) nécessaire.

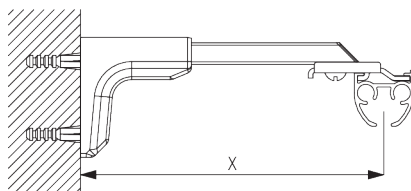

**Universal Smart Fix SG 11154 - SG 11156
et support SG 3832:**
Vis SG 10407 (M4x10) nécessaire.

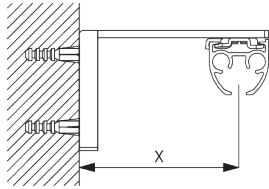

Smart Fix SG 11200 - SG 11205 et bride SG 3825:
Vis SG 10074 (M4x8) nécessaire.

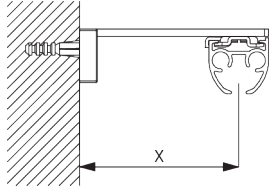

**Square Smart Fix SG 11210 - SG 11215
et bride SG 3825:**
Vis SG 10074 (M4x8) nécessaire.

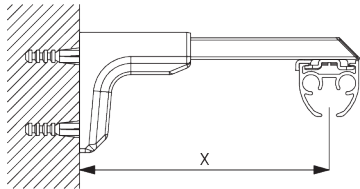

**Universal Smart Fix SG 11154 - SG 11156
et bride SG 3825:**
Vis SG 11158 (M4x12) nécessaire.

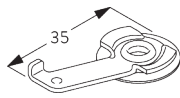

SG 3825
Bride

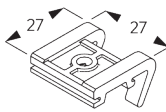

SG 3826
Support

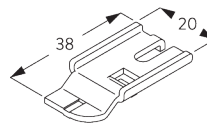

SG 3832
Support



SG 10074
Vis M4x8



SG 10277
Vis M4x12



SG 10407
Vis M4x10



SG 10492
Vis M4x8



SG 11158
Vis M4x12

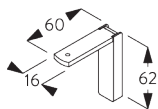

SG 11200
Smart Fix 60 mm

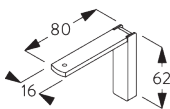

SG 11201
Smart Fix 80 mm

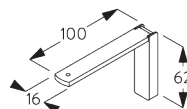

SG 11202
Smart Fix 100 mm

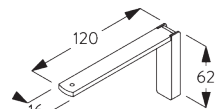

SG 11203
Smart Fix 120 mm

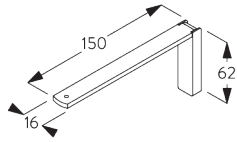

SG 11204
Smart Fix 150 mm

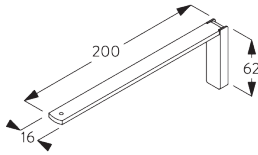

SG 11205
Smart Fix 200 mm

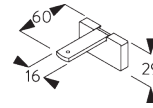

SG 11210
Square Smart Fix 60 mm

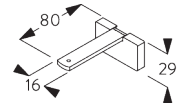

SG 11211
Square Smart Fix 80 mm

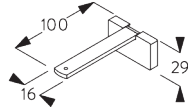

SG 11212
Square Smart Fix 100 mm

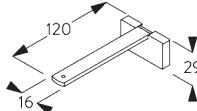

SG 11213
Square Smart Fix 120 mm

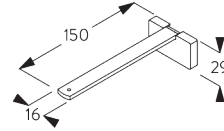

SG 11214
Square Smart Fix 150 mm

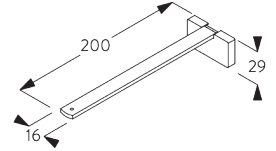

SG 11215
Square Smart Fix 200 mm

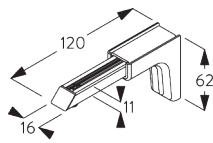

SG 11154
Universal Smart Fix 120 mm

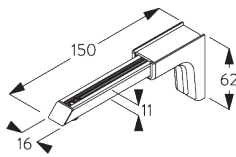

SG 11155
Universal Smart Fix 150 mm

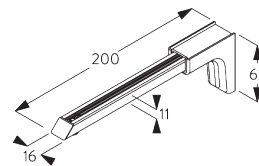

SG 11156
Universal Smart Fix 200 mm

Support SG 3836

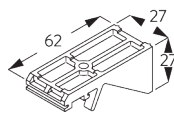
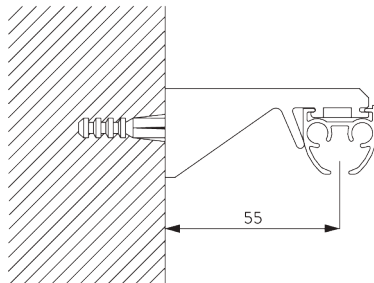

SG 3836
Support

OPTIONS SYSTÈME

A. WAVE

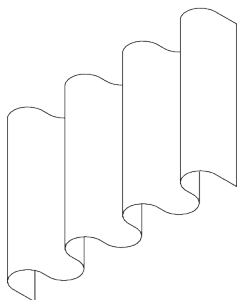

SG 11295

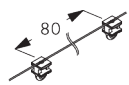

SG 11302

Composants standard:

- SG 11295 Vis d'arrêt
- SG 11302 Glisseurs Wave bi-composants 80 mm

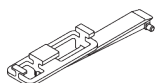

SG 6364



SG 6365

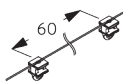

SG 11303

Composants en option (rayon >30 cm):

- SG 6364 Extension Wave
- SG 6365 Crochet Wave
- SG 11303 Glisseur Wave bi-composants 60 mm



SG 3582

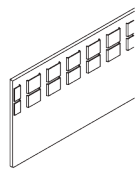

SG 6349

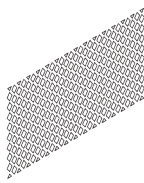

SG 6363

Composants de rideaux:

- SG 3582 Crochet
- SG 6349 Ruban Wave transparent
- SG 6363 Ruban à repasser
- SG 10075 Fil à plomb 50 gr/m
- SG 10076 Barre de lestage

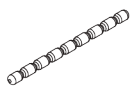

SG 10075



SG 10076

Paquet rideau Wave - Glisseur Bi-composants (standard)

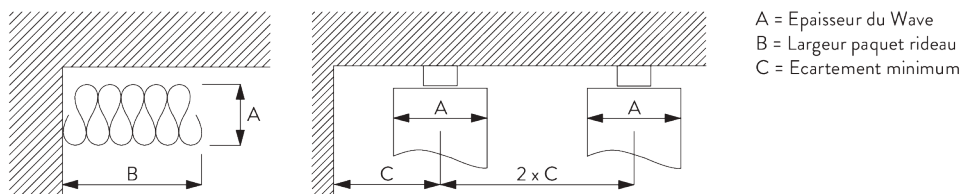

A = Epaisseur du Wave
 B = Largeur paquet rideau
 C = Ecartement minimum

Glisseur Bi-composants SG 11302	Nombre de poches entre crochets	Ampleur rideau Approximative	Epaisseur du Wave A	Largeur paquet rideau B	Ecartement minimum C
80	6	~2.1	140	180 mm par ml de triangle	90
80	7	~2.3	160	180 mm par ml de triangle	100

Glisseur Bi-composants SG 11303	Nombre de poches entre crochets	Ampleur rideau Approximative	Epaisseur du Wave A	Largeur paquet rideau B	Ecartement minimum C
60	4	~2.1	100	230 mm par ml de triangle	70
60	5	~2.3	120	230 mm par ml de triangle	80

**Dimension paquet rideau B standard*





- simple rideau = plus 130 mm par rideau
- deux rideaux = plus 30 mm par rideau

**Dimension paquet rideau B option*





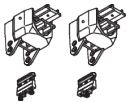
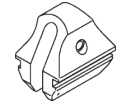
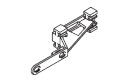







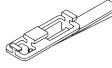

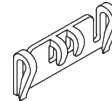

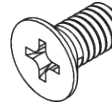
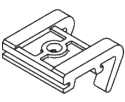

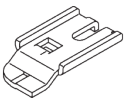
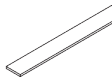
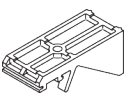
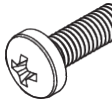
- simple rideau = plus 200 mm par rideau
- deux rideaux = plus 200 mm par rideau

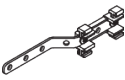
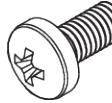
ACCESSOIRES

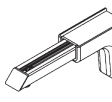
A. ACCESSOIRES STANDARDS

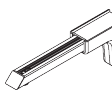
	SG 3090 Corde ø 3.5 mm
	SG 3825 Bride
	SG 3841 Profil
	SG 3845 Set poulies
	SG 6086 Ressort d'arrêt delrin
	SG 6288 Chariot croisant
	SG 10731 Poulie de sécurité pour chaînette & cordon
	SG 11300 Glisseur Bi-composants

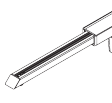
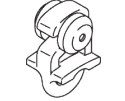
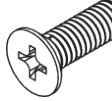
B. ACCESSOIRES EN OPTION

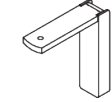
	SG 3340 Contrepoids		SG 6363 Ruban à repasser
	SG 3582 Agrafe Delrin		SG 6364 Extension
	SG 3735 Tendeur		SG 6365 Crochet Wave
	SG 3802 Pièce de raccord		SG 10074 Vis M4x8
	SG 3826 Support		SG 10075 Fil à plomb 50 gr/m
	SG 3832 Support		SG 10076 Barre de lestage
	SG 3836 Support		SG 10277 Vis M4x12
	SG 6053 Ressort d'arrêt		SG 10407 Vis M4x10
	SG 6063 Chariot croisant		SG 10492 Vis M4x8
	SG 6065 Fixateur avec oeillet		SG 11154 Universal Smart Fix 120 mm
	SG 6094 Rouleur		SG 11155 Universal Smart Fix 150 mm
	SG 6098 Rouleur		SG 11156 Universal Smart Fix 200 mm
	SG 6283 Rouleur		SG 11158 Vis M4x12
	SG 6349 Ruban Wave transparent		SG 11200 Smart Fix 60 mm

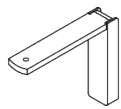

SG 11201
Smart Fix 80 mm

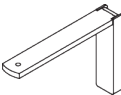

SG 11202
Smart Fix 100 mm

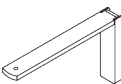

SG 11203
Smart Fix 120 mm

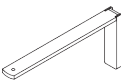

SG 11204
Smart Fix 150 mm



SG 11205
Smart Fix 200 mm

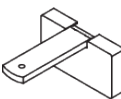

SG 11210
Square Smart Fix 60 mm

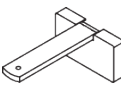

SG 11211
Square Smart Fix 80 mm

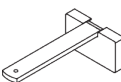

SG 11212
Square Smart Fix 100 mm

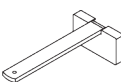

SG 11213
Square Smart Fix 120 mm

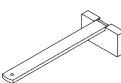

SG 11214
Square Smart Fix 150 mm

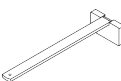

SG 11215
Square Smart Fix 200 mm

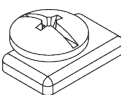

SG 11295
Arrêt



SG 11301
Glisseur Bi-composants en barrette

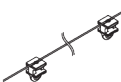

SG 11302
Glisseur Wave Bi-composants 80 mm

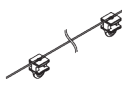

SG 11303
Glisseur Wave Bi-composants 60 mm

SG 3870

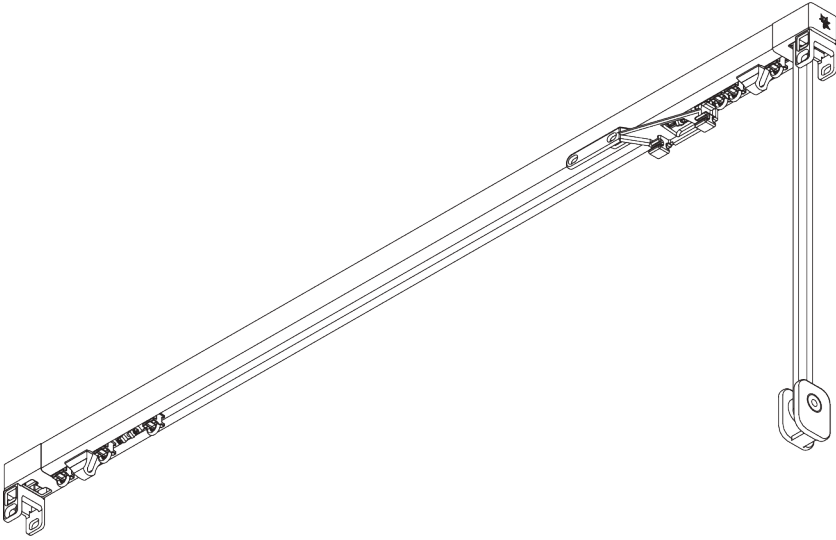
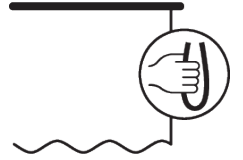

INFORMATION PRODUIT

- **Mode de commande:** Tirage cordon
- **Gamme:** M - L
- **Installation:** Plafond, murale, encastrée
- **Couleurs:** Blanc RAL 9016, Noir RAL 9005 ou Aluminium, couleurs spéciales possibles (profil d'encastrement uniquement en blanc RAL 9016, Noir RAL 9005 ou couleur spéciale)
- **Tissus:** Se référer à la collection tissu Silent Gliss

Caractéristiques:

- Glisseurs bi-composants
- Option Wave Glisseur bi-composants
- Cintrable
- Profil d'encastrement cintrable

SPÉCIFICATION SYSTÈME

A. DIMENSIONS SYSTÈME

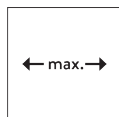

6 m

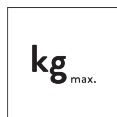

14 kg

Poids maximum du rideau avec glisseur bi-composants ou rouleur

	2 m	4 m	6 m
	12	11	10
	14	13	12
	9	8	7
	10	9	6
	6	5	4
	7	6	5
	5	4	3
	6	5	4

(kg max.)

Poids maximum du rideau avec glisseur Wave bi-composants

	2 m	4 m	6 m
	5	8	7
	5	8	8
	5	6	5
	5	6	6
	4	3	-
	4	4	3
	3	2	-
	3	3	-

(kg max.)

B. PROFIL

Profil et information de cintrage

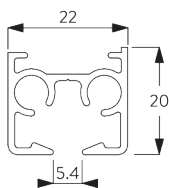

SG 11190

Profil

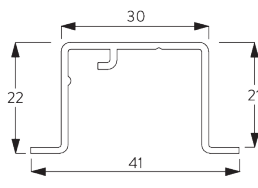

SG 11230

Profil d'encastrement



C. PRISE DE MESURE

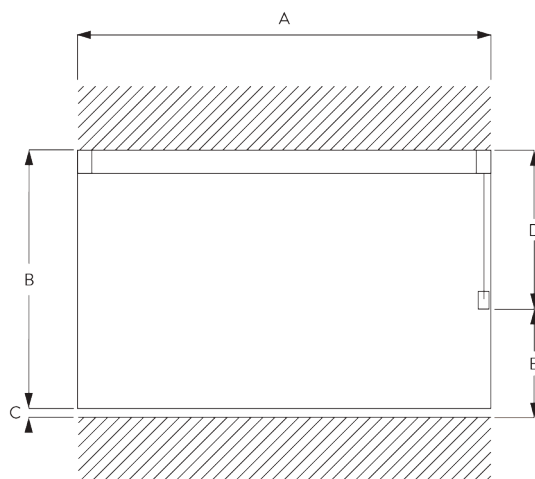

A: Largeur système
B: Hauteur système
C: Distance entre bas du rideau et le sol
D: Hauteur corde
E: Sécurité SG 10731, min. 150 cm du sol

INSTALLATION

A. INSTRUCTION DE POSE

Pour des informations détaillées, se référer au site web Silent Gliss.

Points de fixation

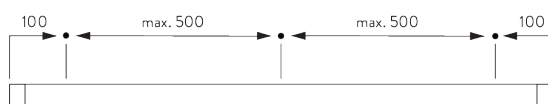

B. FIXATION PLAFOND

Bride SG 3825

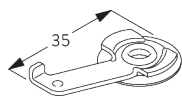
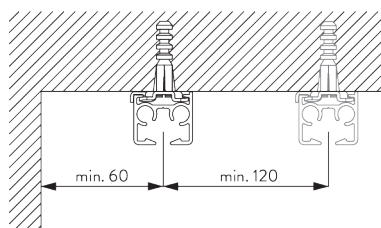

SG 3825

Bride

Support SG 3826

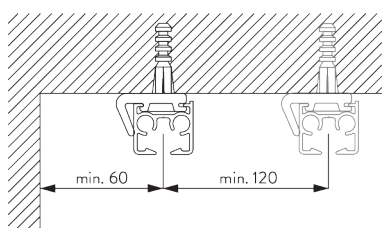

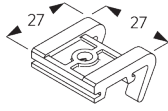

SG 3826
Support

Support SG 3832

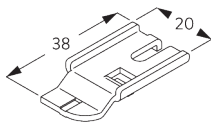
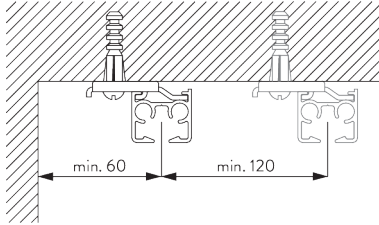

SG 3832
Support

**C. FIXATION
MURALE**

Smart Fix

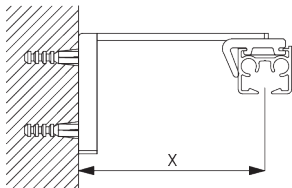

Smart Fix SG 11200 - SG 11205 et support SG 3826:
Vis SG 10492 (M4x8) nécessaire.

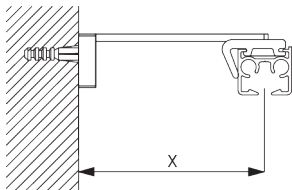

**Square Smart Fix SG 11210 - SG 11215
et support SG 3826:**
Vis SG 10492 (M4x8) nécessaire.

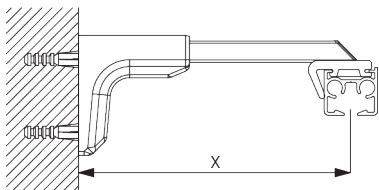

**Universal Smart Fix SG 11154 - SG 11156
et support SG 3826:**
Vis SG 10277 (M4x12) nécessaire.

Smart Fix	X mm (SG 3826 / SG 3825)	X mm (SG 3832)
SG 11200 / SG 11210	52	70
SG 11201 / SG 11211	72	90
SG 11202 / SG 11212	92	110
SG 11203 / SG 11213	112	130
SG 11204 / SG 11214	142	160
SG 11205 / SG 11215	192	210
SG 11154	102 - 130	120 - 148
SG 11155	132 - 160	150 - 178
SG 11156	182 - 210	200 - 228

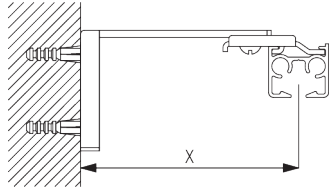

Smart Fix SG 11200 - SG 11205 et support SG 3832:
Vis SG 10492 (M4x8) nécessaire.

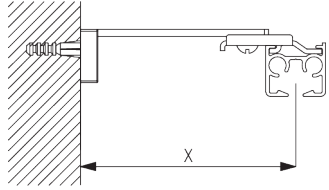

**Square Smart Fix SG 11210 - SG 11215
et support SG 3832:**
Vis SG 10492 (M4x8) nécessaire.

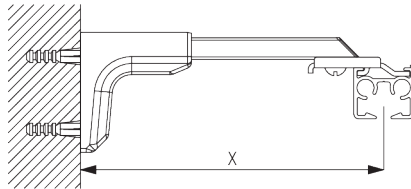

**Universal Smart Fix SG 11154 - SG 11156
et support SG 3832:**
Vis SG 10407 (M4x10) nécessaire.

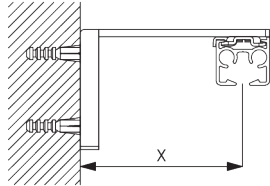

Smart Fix SG 11200 - SG 11205 et bride SG 3825:
Vis SG 10074 (M4x8) nécessaire.

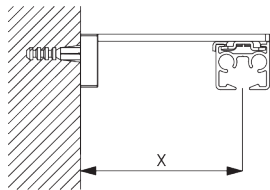

**Square Smart Fix SG 11210 - SG 11215
et bride SG 3825:**
Vis SG 10074 (M4x8) nécessaire.

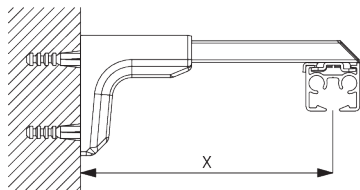

**Universal Smart Fix SG 11154 - SG 11156
et bride SG 3825:**
Vis SG 11158 (M4x12) nécessaire.

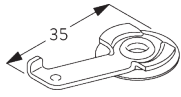

SG 3825
Bride

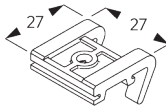

SG 3826
Support

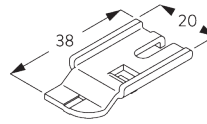

SG 3832
Support



SG 10074
Vis M4x8



SG 10277
Vis M4x12



SG 10407
Vis M4X10



SG 10492
Vis M4x8



SG 11158
Vis M4x12

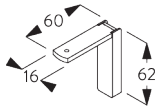

SG 11200
Smart Fix 60 mm

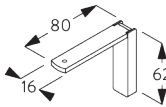

SG 11201
Smart Fix 80 mm

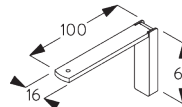

SG 11202
Smart Fix 100 mm

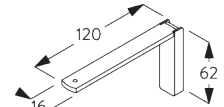

SG 11203
Smart Fix 120 mm

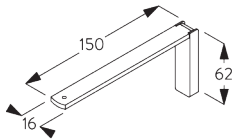

SG 11204
Smart Fix 150 mm

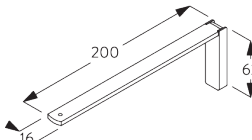

SG 11205
Smart Fix 200 mm

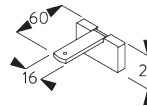

SG 11210
Square Smart Fix 60 mm

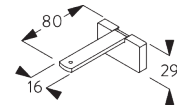

SG 11211
Square Smart Fix 80 mm

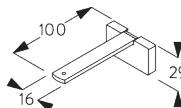

SG 11212
Square Smart Fix 100 mm

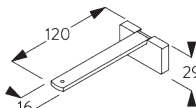

SG 11213
Square Smart Fix 120 mm

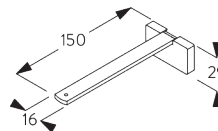

SG 11214
Square Smart Fix 150 mm

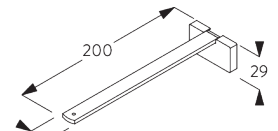

SG 11215
Square Smart Fix 200 mm

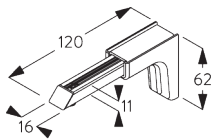

SG 11154
Universal Smart Fix 120 mm

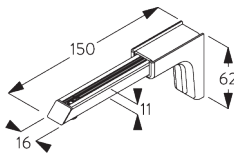

SG 11155
Universal Smart Fix 150 mm

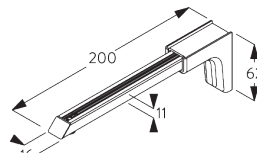

SG 11156
Universal Smart Fix 200 mm

Support SG 3836

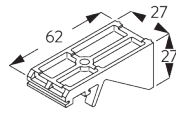
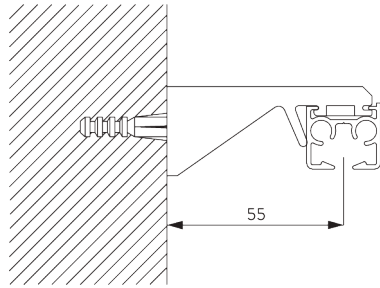

SG 3836

Support

D. FIXATION ENCASTREE

Profil d'encastrement SG 11230

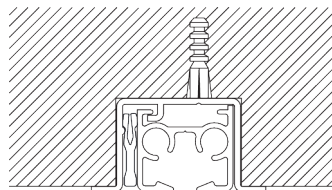

Une cale de blocage SG 10157 par point de fixation
Pour des informations détaillées sur l'installation encastrée,
se référer au site Silent Gliss.

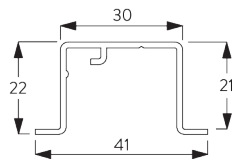

SG 11230

Profil d'encastrement

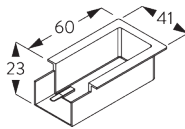

SG 11238

Masque profil encastrement

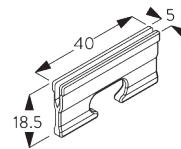

SG 10157

Clip blocage pour profil
d'encastrement

OPTIONS SYSTÈME

A. WAVE

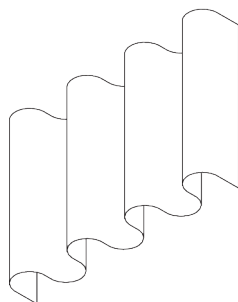

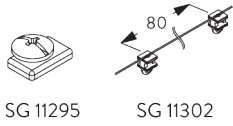

SG 11295

SG 11302

Composants standard:

- SG 11295 Vis d'arrêt
- SG 11302 Glisseurs Wave bi-composants 80 mm

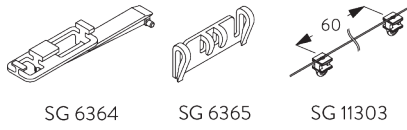

SG 6364

SG 6365

SG 11303

Composants en option:

- SG 6364 Extension Wave
- SG 6365 Crochet Wave
- SG 11303 Glisseur Wave bi-composants 60 mm

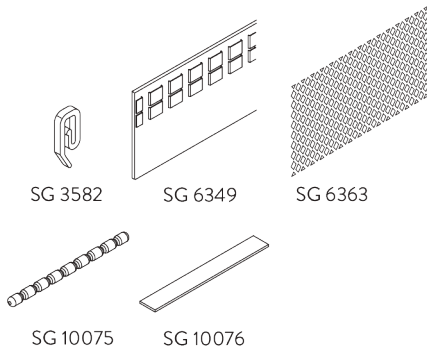

SG 3582

SG 6349

SG 6363

SG 10075

SG 10076

Composants de rideaux:

- SG 3582 Crochet
- SG 6349 Ruban Wave transparent
- SG 6363 Ruban à repasser
- SG 10075 Fil à plomb 50 gr/m
- SG 10076 Barre de lestage

Paquet rideau Wave - Glisseur Bi-composants (standard)

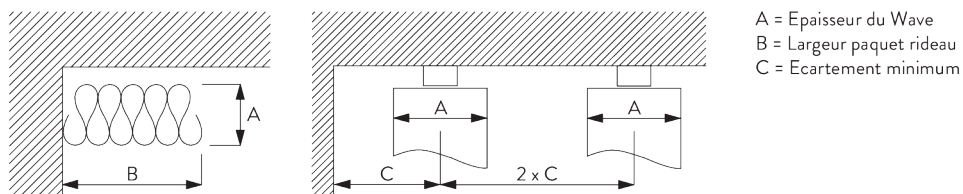

A = Epaisseur du Wave
 B = Largeur paquet rideau
 C = Ecartement minimum

Glisseur Bi-composants SG 11302	Nombre de poches entre crochets	Ampleur rideau Approximative	Epaisseur du Wave A	Largeur paquet rideau B	Ecartement minimum C
80	6	~2.1	140	180 mm par ml de triangle	90
80	7	~2.3	160	180 mm par ml de triangle	100

Glisseur Bi-composants SG 11303	Nombre de poches entre crochets	Ampleur rideau Approximative	Epaisseur du Wave A	Largeur paquet rideau B	Ecartement minimum C
60	4	~2.1	100	230 mm par ml de triangle	70
60	5	~2.3	120	230 mm par ml de triangle	80

**Dimension paquet rideau B standard*







- simple rideau = plus 130 mm par rideau
- deux rideaux = plus 30 mm par rideau

**Dimension paquet rideau B option*



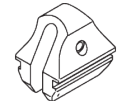
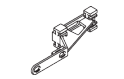
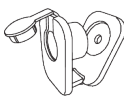







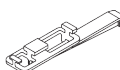

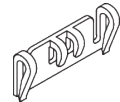

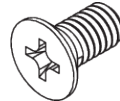
- simple rideau = plus 200 mm par rideau
- deux rideaux = plus 200 mm par rideau

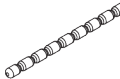
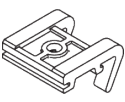
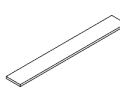
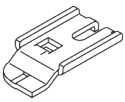
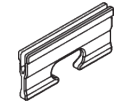
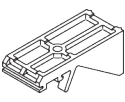
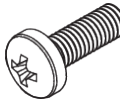
ACCESSOIRES

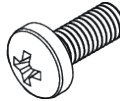
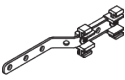
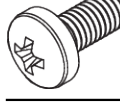
A. ACCESSOIRES STANDARDS

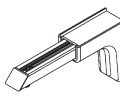
	SG 3090 Corde ø 3.5 mm
	SG 3825 Bride
	SG 6086 Ressort d'arrêt delrin
	SG 6288 Chariot croisant
	SG 10731 Poulie de sécurité pour chaînette & cordon
	SG 11190 Profil
	SG 11285 Set poulies
	SG 11300 Glisseur Bi-composants

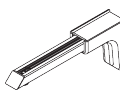
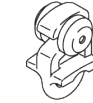
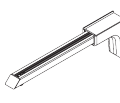
B. ACCESSOIRES EN OPTION

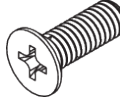
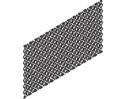
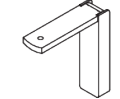
	SG 3340 Contrepoids		SG 6364 Extension
	SG 3582 Agrafe Delrin		SG 6365 Crochet Wave
	SG 3735 Tendeur		SG 10074 Vis M4x8
	SG 3802 Pièce de raccord		SG 10075 Fil à plomb 50 gr/m
	SG 3826 Support		SG 10076 Barre de lestage
	SG 3832 Support		SG 10157 Clip blocage pour profil d'encastrement
	SG 3836 Support		SG 10277 Vis M4x12
	SG 6053 Ressort d'arrêt		SG 10407 Vis M4x10
	SG 6063 Chariot croisant		SG 10492 Vis M4x8
	SG 6094 Rouleur		SG 11154 Universal Smart Fix 120 mm
	SG 6098 Rouleur		SG 11155 Universal Smart Fix 150 mm
	SG 6283 Rouleur		SG 11156 Universal Smart Fix 200 mm
	SG 6349 Ruban Wave transparent		SG 11158 Vis M4x12
	SG 6363 Ruban à repasser		SG 11200 Smart Fix 60 mm

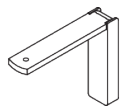

SG 11201
Smart Fix 80 mm

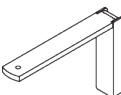

SG 11202
Smart Fix 100 mm

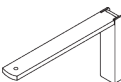

SG 11203
Smart Fix 120 mm



SG 11204
Smart Fix 150 mm



SG 11205
Smart Fix 200 mm

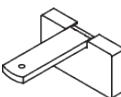

SG 11210
Square Smart Fix 60 mm

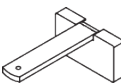

SG 11211
Square Smart Fix 80 mm

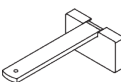

SG 11212
Square Smart Fix 100 mm

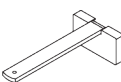

SG 11213
Square Smart Fix 120 mm

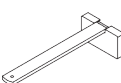

SG 11214
Square Smart Fix 150 mm

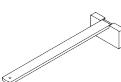

SG 11215
Square Smart Fix 200 mm

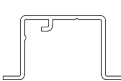

SG 11230
Profil d'encastrement

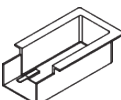

SG 11238
Masque profil encastrement

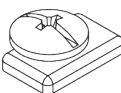

SG 11295
Arrêt



SG 11301
Glisseur Bi-composants en barrette

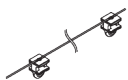

SG 11302
Glisseur Wave Bi-composants 80 mm

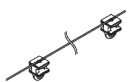

SG 11303
Glisseur Wave Bi-composants 60 mm

SG 3900

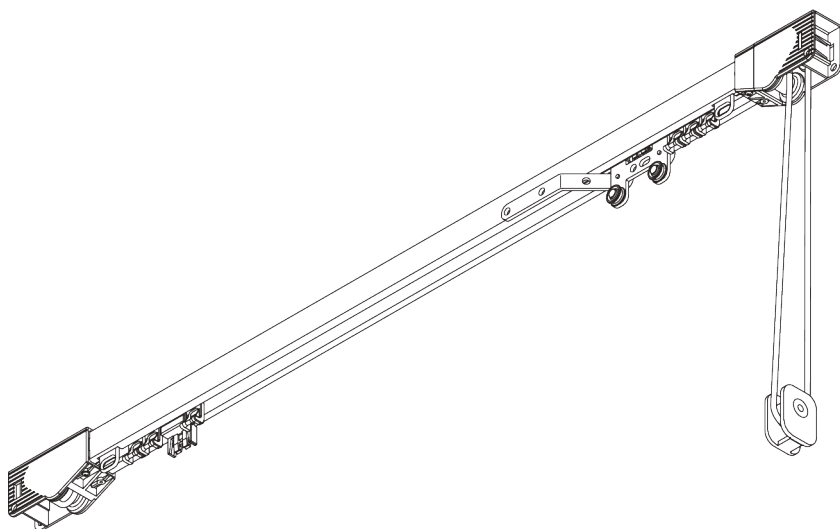
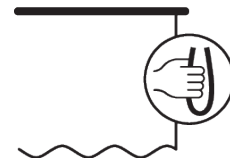

INFORMATION PRODUIT

- **Mode de commande:** Tirage cordon
- **Gamme:** M - L
- **Installation:** Plafond, murale, suspende
- **Couleurs:** Blanc RAL 9016 ou Aluminium, couleurs spéciales possibles
- **Tissus:** Se référer à la collection tissu Silent Gliss

Caractéristiques:

- Cintrable

SPÉCIFICATION SYSTÈME

A. DIMENSIONS SYSTÈME



12 m

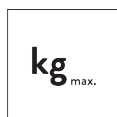

20 kg

Poids maximum du rideau

	2 m	4 m	6 m	8 m	10 m	12 m
	8	12	16	15	13	11
	8	14	20	18	15	13
	10	11	11	10	8	7
	10	14	14	13	13	12
	10	11	11	11	10	10
	10	12	12	11	11	10
	8	8	7	6	5	4
	10	10	9	8	7	6

(kg max.)

B. PROFIL

Profil et information de cintrage

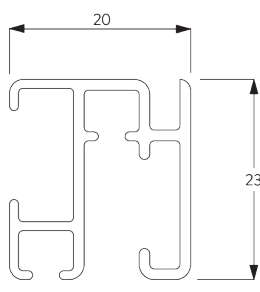

SG 3982

Profil

✓ Rayon:
15 cm, 20 cm, >30 cm

C. PRISE DE MESURE

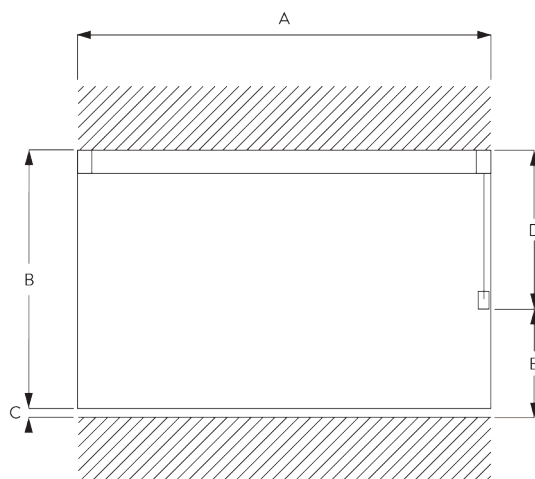

A: Largeur système
B: Hauteur système
C: Distance entre bas du rideau et le sol
D: Hauteur corde
E: Sécurité SG 10731, min. 150 cm du sol

INSTALLATION

A. INSTRUCTION DE POSE

Pour des informations détaillées, se référer au site web Silent Gliss.

Points de fixation

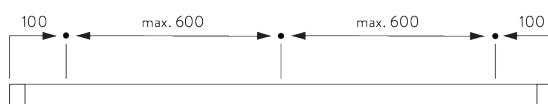

B. FIXATION PLAFOND

Support SG 3603

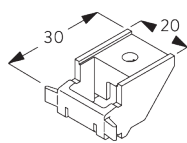
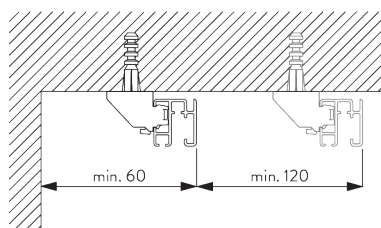

SG 3603

Support plafond

C. FIXATION AVEC SUSPENTE

Suspente SG 3639

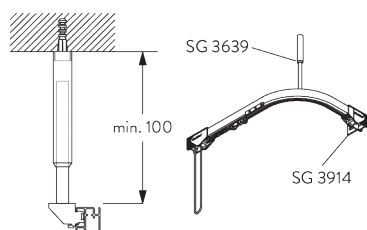

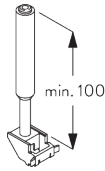

SG 3639
Suspension

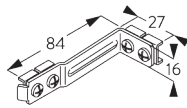

SG 3914
Support poulie retour

D. FIXATION MURALE

Smart Fix

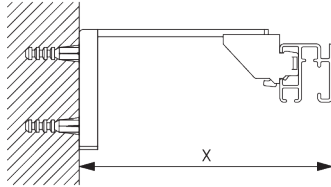

Smart Fix SG 11200 - SG 11205 et support SG 3603:
Vis SG 10492 (M4x8) nécessaire.

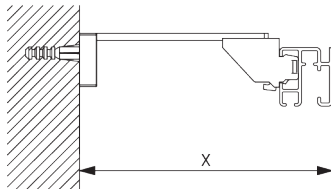

Square Smart Fix SG 11210 - SG 11215 et support SG 3603:
Vis SG 10492 (M4x8) nécessaire.

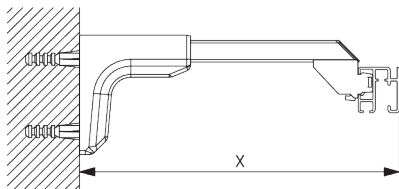

Universal Smart Fix SG 11154 - SG 11156 et support SG 3603:
Vis SG 10277 (M4x12) nécessaire.

Smart Fix	X mm
SG 11200 / SG 11210	86
SG 11201 / SG 11211	106
SG 11202 / SG 11212	126
SG 11203 / SG 11213	146
SG 11204 / SG 11214	176
SG 11205 / SG 11215	226
SG 11154	136 - 164
SG 11155	166 - 194
SG 11156	216 - 244

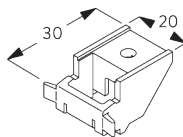

SG 3603
Support plafond



SG 10277
Vis M4x12



SG 10492
Vis M4x8

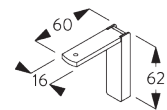

SG 11200
Smart Fix 60 mm

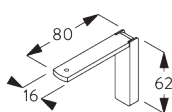

SG 11201
Smart Fix 80 mm

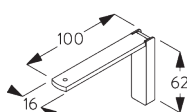

SG 11202
Smart Fix 100 mm

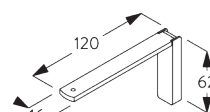

SG 11203
Smart Fix 120 mm

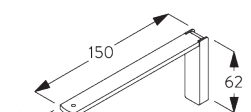

SG 11204
Smart Fix 150 mm

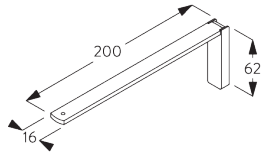

SG 11205
Smart Fix 200 mm

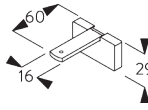

SG 11210
Square Smart Fix 60 mm

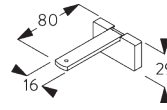

SG 11211
Square Smart Fix 80 mm

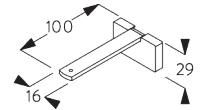

SG 11212
Square Smart Fix 100 mm

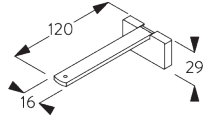

SG 11213
Square Smart Fix 120 mm

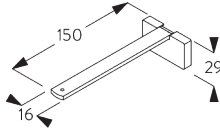

SG 11214
Square Smart Fix 150 mm

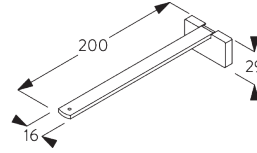

SG 11215
Square Smart Fix 200 mm

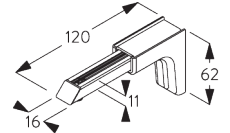

SG 11154
Universal Smart Fix 120 mm

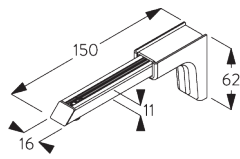

SG 11155
Universal Smart Fix 150 mm

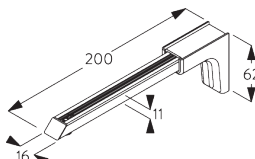

SG 11156
Universal Smart Fix 200 mm

**Supports universel
SG 3630, SG 3655,
SG 3660**

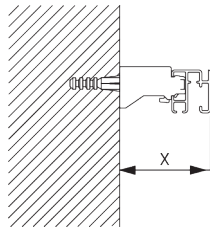

Support	X mm
SG 3630	49
SG 3655	59
SG 3660	79

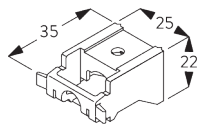

SG 3630
Support 35 mm

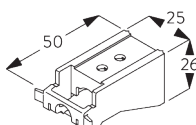



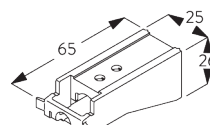

SG 3655
Support 50 mm





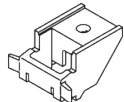

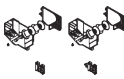
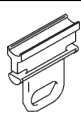
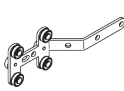

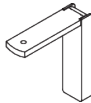

SG 3660
Support 65 mm

ACCESSOIRES

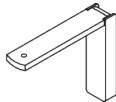
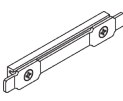
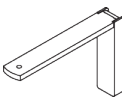
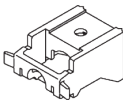
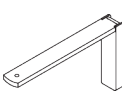
A. ACCESSOIRES STANDARDS

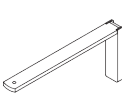
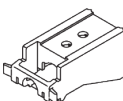
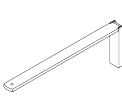
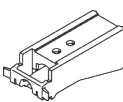
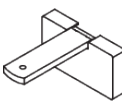
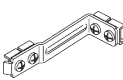
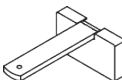
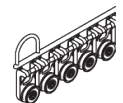
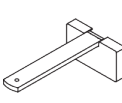
	SG 3090 Corde ø 3.5 mm
	SG 3603 Support plafond
	SG 3911 Rouleur
	SG 3915 Set poulies
	SG 3932 Ressort d'arrêt
	SG 3936 Chariot croisant
	SG 3982 Profil
	SG 10731 Poulie de sécurité pour chaînette & cordon

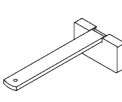
B. ACCESSOIRES EN OPTION

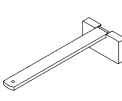
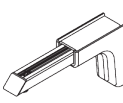
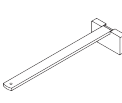
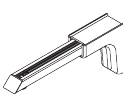
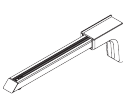
	SG 3340 Contrepoids		SG 11200 Smart Fix 60 mm
	SG 3582 Agrafe Delrin		SG 11201 Smart Fix 80 mm
	SG 3620 Pièce de raccord		SG 11202 Smart Fix 100 mm
	SG 3630 Support 35 mm		SG 11203 Smart Fix 120 mm
	SG 3639 Suspension		SG 11204 Smart Fix 150 mm
	SG 3655 Support 50 mm		SG 11205 Smart Fix 200 mm
	SG 3660 Support 65 mm		SG 11210 Square Smart Fix 60 mm
	SG 3914 Support poulie retour		SG 11211 Square Smart Fix 80 mm
	SG 3922 Rouleur 3911 en barrette		SG 11212 Square Smart Fix 100 mm
	SG 10277 Vis M4x12		SG 11213 Square Smart Fix 120 mm
	SG 10492 Vis M4x8		SG 11214 Square Smart Fix 150 mm
	SG 11154 Universal Smart Fix 120 mm		SG 11215 Square Smart Fix 200 mm
	SG 11155 Universal Smart Fix 150 mm		
	SG 11156 Universal Smart Fix 200 mm		

SG 3970

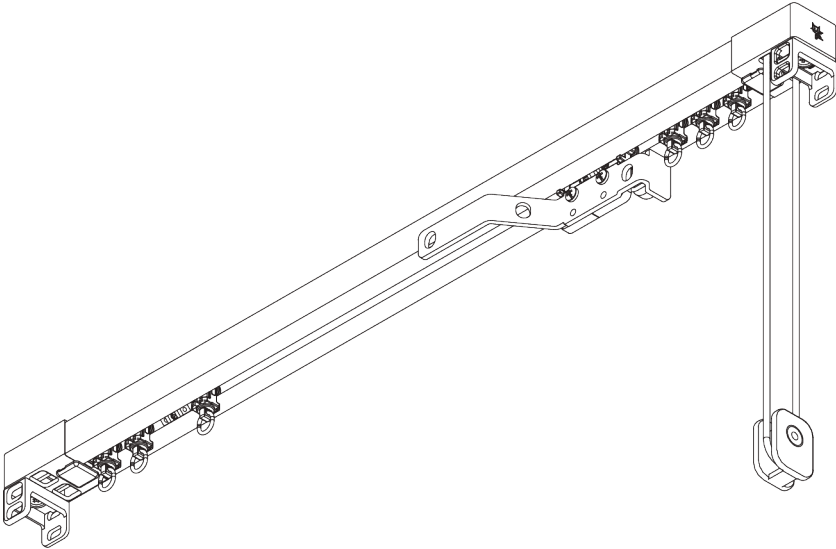
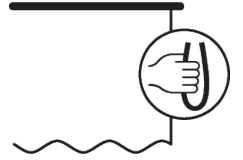

INFORMATION PRODUIT

- **Mode de commande:** Tirage cordon
- **Gamme:** M - L
- **Installation:** Plafond, murale, encastrée
- **Couleurs:** Blanc RAL 9016 ou Aluminium, couleurs spéciales possibles (profil d'encastrement uniquement en blanc RAL 9016 ou couleur spéciale)
- **Tissus:** Se référer à la collection tissu Silent Gliss

Caractéristiques:

- Glisseurs bi-composants
- Option Wave Glisseur bi-composants
- Cintrable
- Cintrable avec profil d'encastrement

SPÉCIFICATION SYSTÈME

A. DIMENSIONS SYSTÈME

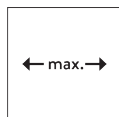

15 m

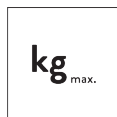

38 kg

Poids maximum du rideau avec rouleurs bi-composants ou rouleurs Wave bi-composants

	2 m	4 m	6 m	8 m	10 m	12 m	15 m
	25	38	35	30	25	20	15
	25	38	35	30	25	20	15
	25	30	25	20	18	15	10
	25	30	25	20	18	15	10
	13	16	13	11	10	8	6
	13	16	13	11	10	8	6
	11	13	11	10	9	7	-
	11	13	11	10	9	7	-

(kg max.)

B. PROFIL

Profil et information de cintrage

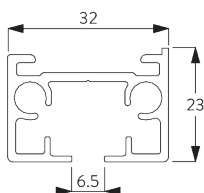

SG 3971

Profil

✓ Rayon: >25 cm

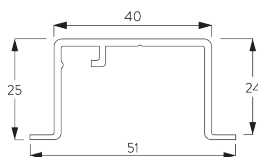

SG 10862

Profil d'encastrement

✓ Rayon: 50 - 75 cm
>75 cm sur demande

C. PRISE DE MESURE

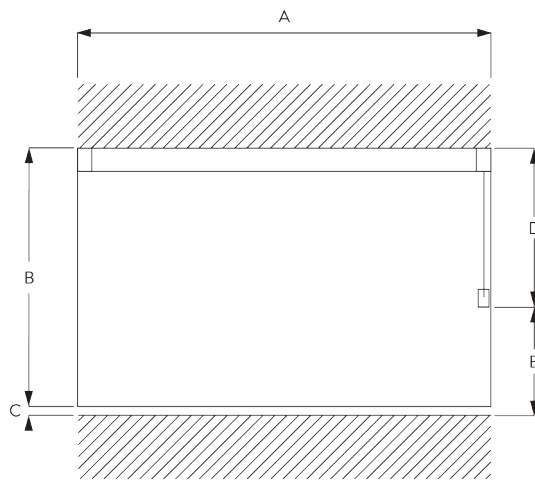

A: Largeur système
B: Hauteur système
C: Distance entre bas du rideau et le sol
D: Hauteur corde
E: Sécurité SG 10731. min. 150 cm du sol

INSTALLATION

A. INSTRUCTION DE POSE

Pour des informations détaillées, se référer au site web *Silent Gliss*.

Points de fixation

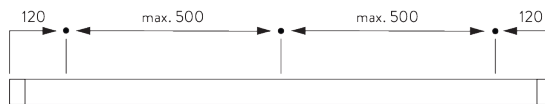

B. FIXATION PLAFOND

Bride SG 3004

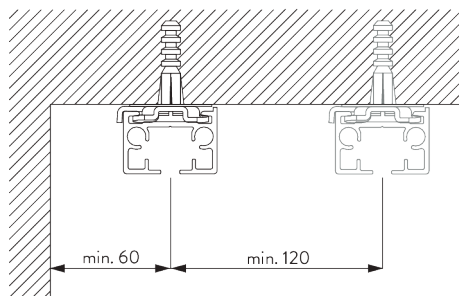

SG 3004
Bride

Fixation directe plafond

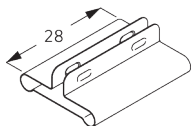
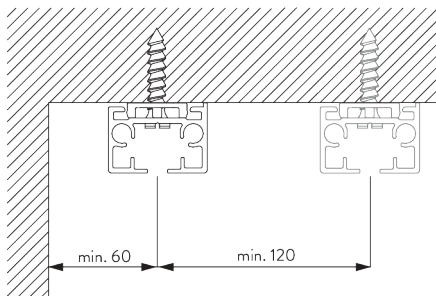

SG 7002

Protecteur de profil

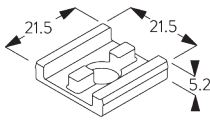

SG 10865

Clip pour montage

Support SG 3041

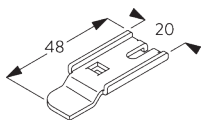
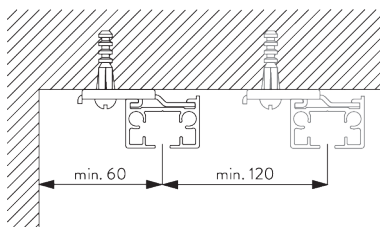

SG 3041

Support

C. FIXATION MURALE

Smart Fix

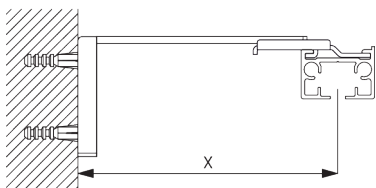

Smart Fix SG 11200 - SG 11205 et support SG 3041:
Vis SG 10492 (M4x8) nécessaire.

Smart Fix	X mm (SG 3041)	X mm (SG 3004)
SG 11200 / SG 11210	83	
SG 11201 / SG 11211	103	72
SG 11202 / SG 11212	123	92
SG 11203 / SG 11213	143	112
SG 11204 / SG 11214	173	142
SG 11205 / SG 11215	223	192
SG 11154	128 - 156	102 - 130
SG 11155	158 - 186	132 - 160
SG 11156	208 - 236	182 - 210

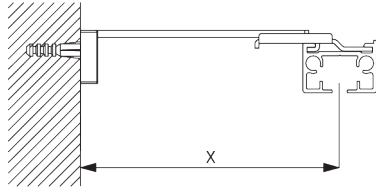

Square Smart Fix SG 11210 - SG 11215
et support SG 3041:
 Vis SG 10492 (M4x8) nécessaire.

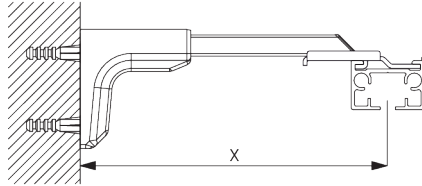

Universal Smart Fix SG 11154 - SG 11156
et support SG 3041:
 Vis SG 10407 (M4x10) nécessaire.

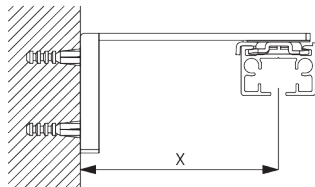

Smart Fix SG 11201 - SG 11205 et bride SG 3004:
 Vis SG 10074 (M4x8) nécessaire.

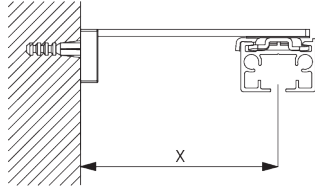

Square Smart Fix SG 11211 - SG 11215
et bride SG 3004:
 Vis SG 10074 (M4x8) nécessaire.

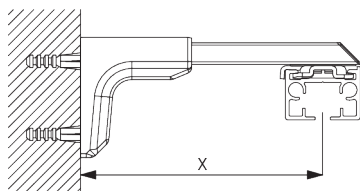

Universal Smart Fix SG 11154 - SG 11156
et bride SG 3004:
 Vis SG 11158 (M4x12) nécessaire.

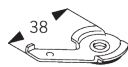

SG 3004
 Bride

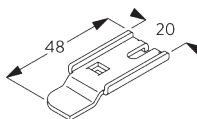

SG 3041
 Support



SG 10074
 Vis M4x8



SG 10407
 Vis M4X10



SG 10492
Vis M4x8



SG 11158
Vis M4x12

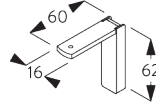

SG 11200
Smart Fix 60 mm

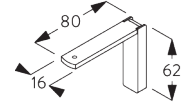

SG 11201
Smart Fix 80 mm

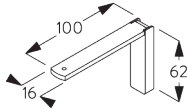

SG 11202
Smart Fix 100 mm

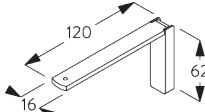

SG 11203
Smart Fix 120 mm

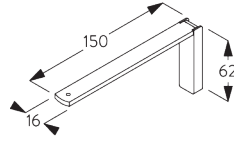

SG 11204
Smart Fix 150 mm

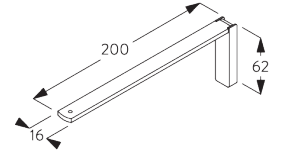

SG 11205
Smart Fix 200 mm

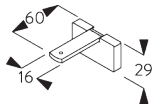

SG 11210
Square Smart Fix 60 mm

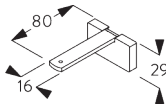

SG 11211
Square Smart Fix 80 mm

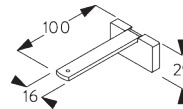

SG 11212
Square Smart Fix 100 mm

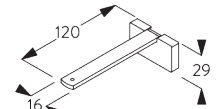

SG 11213
Square Smart Fix 120 mm

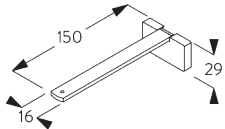

SG 11214
Square Smart Fix 150 mm

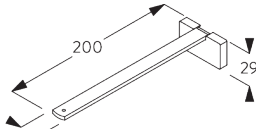

SG 11215
Square Smart Fix 200 mm

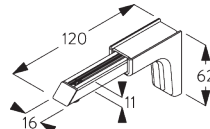

SG 11154
Universal Smart Fix 120 mm

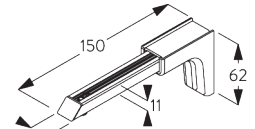

SG 11155
Universal Smart Fix 150 mm

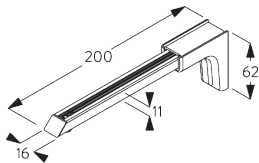

SG 11156
Universal Smart Fix 200 mm

D. FIXATION ENCASTREE

Profil d'encastrement SG 10862

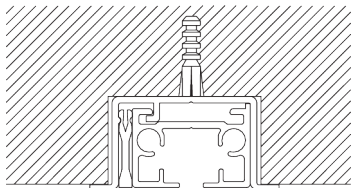

Une cale de blocage SG 5118 par point de fixation.
Pour des informations détaillées sur l'installation encastrée,
se référer au site Silent Gliss.

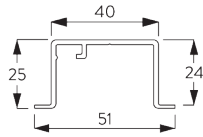

SG 10862
Profil d'encastrement

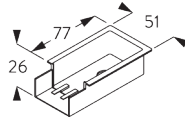

SG 10864
Masque profil d'encastrement

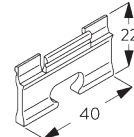

SG 5118
Pièce de blocage

OPTIONS SYSTÈME

A. WAVE

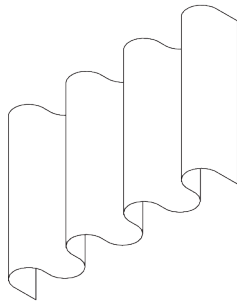

SG 11295

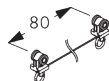

SG 10852



SG 6365

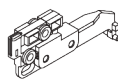

SG 10845



SG 10854



SG 10867

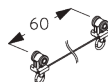

SG 10869

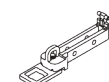

SG 10887

Composants standard:

- SG 11295 Vis d'arrêt
- SG 10852 Rouleur Wave bi-composants 80 mm

Optional components:

- SG 6365 Crochet Wave
- SG 10845 Conducteur Wave 1 rideau 80 mm
- SG 10854 Support de chariot Wave
- SG 10867 Vis M4x16
- SG 10869 Rouleur Wave bi-composants 60 mm (seulement deux rideaux)
- SG 10887 Extension Wave

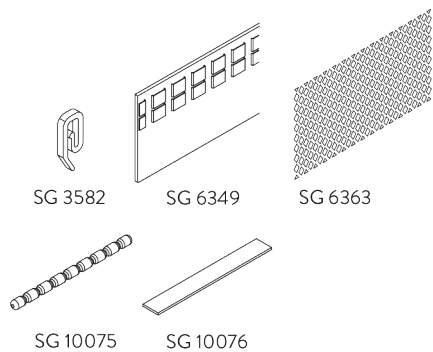

Composants de rideaux:

- SG 3582 Crochet
- SG 6349 Ruban Wave transparent
- SG 6363 Ruban à repasser
- SG 10075 Fil à plomb 50 gr/m
- SG 10076 Barre de lestage

Paquet rideau Wave - Rouler Bi-composants (standard)

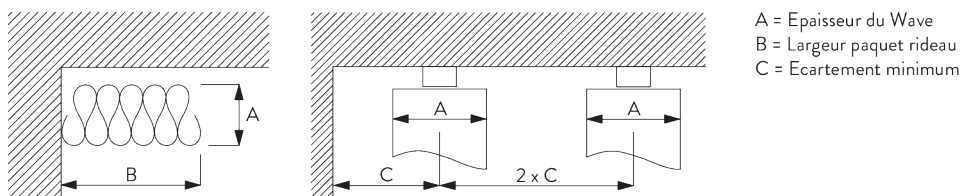

A = Epaisseur du Wave
 B = Largeur paquet rideau
 C = Ecartement minimum

Rouler Bi-composants SG 10852	Nombre de poches entre crochets	Ampleur rideau Approximative	Epaisseur du Wave A	Largeur paquet rideau B*	Ecartement minimum C
80	6	~2.1	140	210 mm par ml de triangle	90
80	7	~2.3	160	210 mm par ml de triangle	100

Rouler Bi-composants SG 10869	Nombre de poches entre crochets	Ampleur rideau Approximative	Epaisseur du Wave A	Largeur paquet rideau B*	Ecartement minimum C
60	4	~2.1	100	260 mm par ml de triangle	70
60	5	~2.3	120	260 mm par ml de triangle	80

*Dimension paquet rideau B standard









- simple rideau = plus 140 mm par rideau
- deux rideaux = plus 40 mm par rideau

*Dimension paquet rideau B option

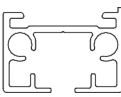

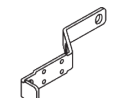
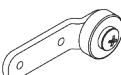

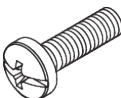
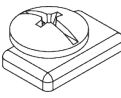

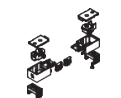

- simple rideau = n/a
- deux rideaux = plus 150 mm par rideau

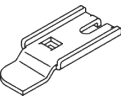
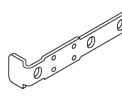
ACCESSOIRES

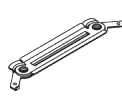
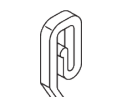
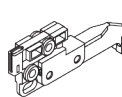
A. ACCESSOIRES STANDARDS

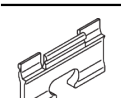
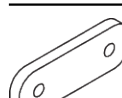
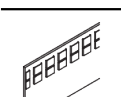
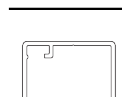
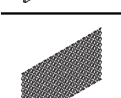
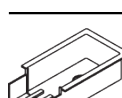
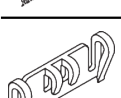
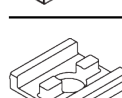
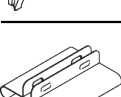
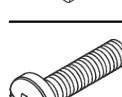
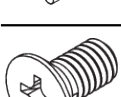
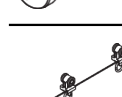
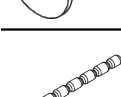
	SG 3004 Bride
	SG 3090 Corde ø 3.5 mm
	SG 3971 Profil
	SG 10731 Poulie de sécurité pour chaînette & cordon
	SG 10821 Chariot recouvrement
	SG 10826 Support de chariot d'entraînement
	SG 10840 Rouleur bi-composant
	SG 10923 Vis M4x12 pour connecteur bande
	SG 11295 Arrêt
	SG 11314 Conducteur
	SG 11315 Set poulies

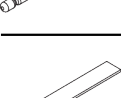
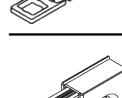
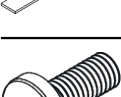
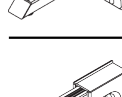
B. ACCESSOIRES EN OPTION

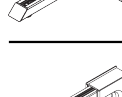
	SG 3041 Support		SG 10820 Chariot droit
	SG 3340 Contrepoids		SG 10831 Pièce de raccordement
	SG 3582 Agrafe Delrin		SG 10845 Conducteur Wave 1 rideau 80 mm
	SG 3735 Tendeur		SG 10852 Rouleur Wave Bi-composants 80 mm
	SG 5118 Pièce de blocage		SG 10854 Support de chariot Wave
	SG 6349 Ruban Wave transparent		SG 10862 Profil d'encastrement
	SG 6363 Ruban à repasser		SG 10864 Masque profil d'encastrement
	SG 6365 Crochet Wave		SG 10865 Clip pour montage
	SG 7002 Protecteur de profil		SG 10867 Vis M4x16
	SG 10074 Vis M4x8		SG 10869 Rouleur Wave Bi-composants 60 mm
	SG 10075 Fil à plomb 50 gr/m		SG 10887 Extension Wave
	SG 10076 Barre de lestage		SG 11154 Universal Smart Fix 120 mm
	SG 10407 Vis M4X10		SG 11155 Universal Smart Fix 150 mm
	SG 10492 Vis M4x8		SG 11156 Universal Smart Fix 200 mm

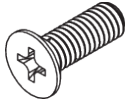

SG 11158

Vis M4x12

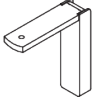

SG 11200

Smart Fix 60 mm

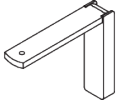

SG 11201

Smart Fix 80 mm

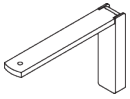

SG 11202

Smart Fix 100 mm

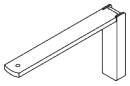

SG 11203

Smart Fix 120 mm

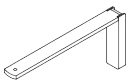

SG 11204

Smart Fix 150 mm



SG 11205

Smart Fix 200 mm

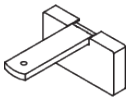

SG 11210

Square Smart Fix 60 mm

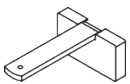

SG 11211

Square Smart Fix 80 mm

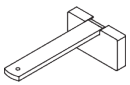

SG 11212

Square Smart Fix 100 mm

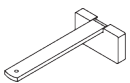

SG 11213

Square Smart Fix 120 mm

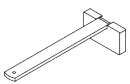

SG 11214

Square Smart Fix 150 mm

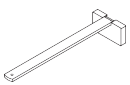

SG 11215

Square Smart Fix 200 mm

SG 6370

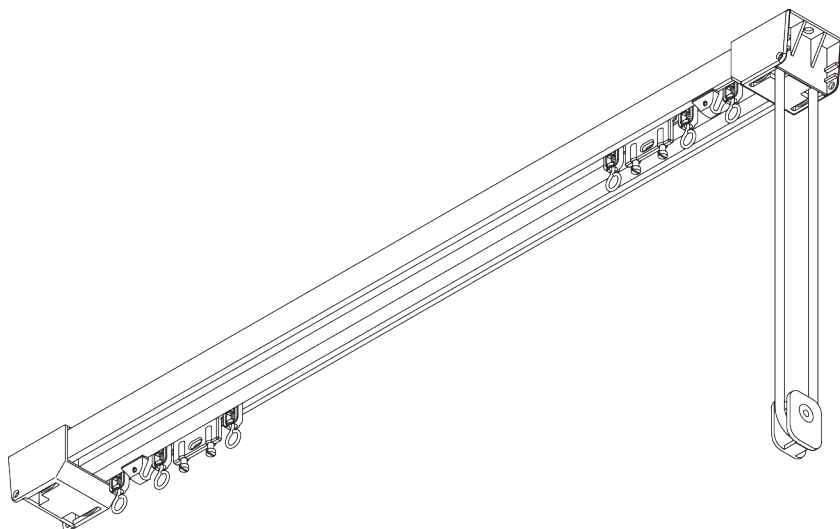
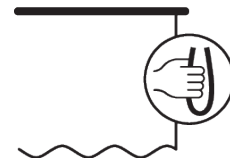

INFORMATION PRODUIT

- **Mode de commande:** Tirage cordon
- **Gamme:** L
- **Installation:** Plafond, murale
- **Couleurs:** Blanc RAL 9016 ou Aluminium, couleurs spéciales possibles
- **Tissus:** Se référer à la collection tissu Silent Gliss

Caractéristiques:

- Cintrable

SPÉCIFICATION SYSTÈME

A. DIMENSIONS SYSTÈME



15 m

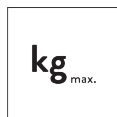

66 kg

Poids maximum du rideau avec rouleur SG 6098 / SG 6094

	2 m	4 m	6 m	8 m	10 m	12 m	15 m
	62	60	58	56	54	50	46
	66	64	62	60	58	55	50
	46	43	40	37	34	30	25
	50	47	44	41	38	35	30
	36	33	30	27	24	22	18
	44	40	36	33	30	28	22
	24	19	14	5	4	-	-
	27	23	19	10	9	-	-

(kg max.)

Poids maximum du rideau avec rouleur SG 6283

	2 m	4 m	6 m	8 m	10 m	12 m	15 m
	45	42	40	38	35	32	28
	46	44	42	40	38	36	34
	32	30	28	26	24	22	18
	34	32	30	28	26	23	20
	24	22	20	18	16	13	10
	29	27	25	23	21	18	15

(kg max.)

B. PROFIL

Profil et information de cintrage

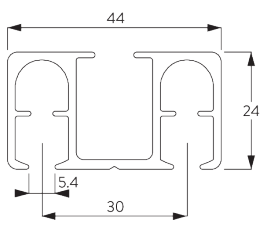

SG 6371

Profil



C. PRISE DE MESURE

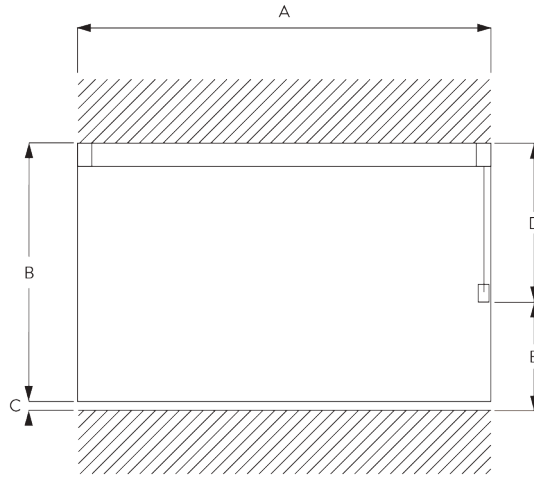

A: Largeur système
 B: Hauteur système
 C: Distance entre bas du rideau et le sol
 D: Hauteur corde
 E: Sécurité SG 10731, min. 150 cm du sol

INSTALLATION

A. INSTRUCTION DE POSE

Pour des informations détaillées, se référer au site web Silent Gliss.

Points de fixation

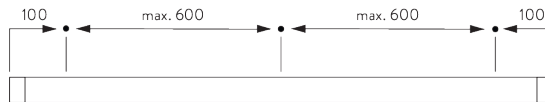

B. FIXATION PLAFOND

Fixation directe plafond

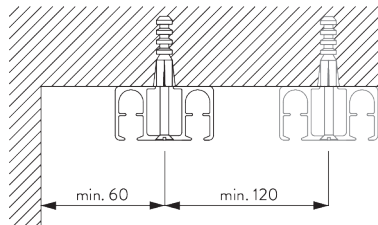

C. FIXATION MURALE

Smart Fix

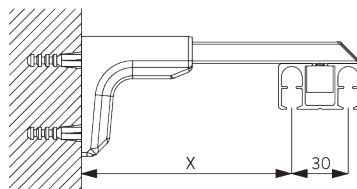

Universal Smart Fix SG 11154 - SG 11156 et bride SG 6369:

Vis SG 11157 (M5x20) nécessaire.

Smart Fix	X mm
SG 11154	87 - 115
SG 11155	117 - 145
SG 11156	167 - 195

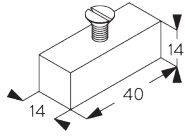

SG 6369
Ecrou



SG 11157
Vis M5x20

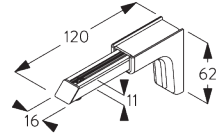

SG 11154
Universal Smart Fix 120 mm

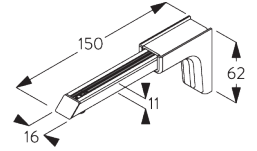



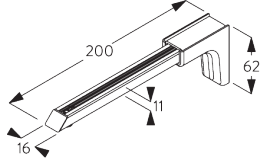

SG 11155
Universal Smart Fix 150 mm





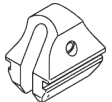

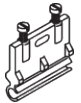
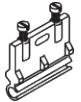

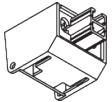
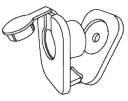
SG 11156
Universal Smart Fix 200 mm

ACCESSOIRES

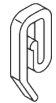
A. ACCESSOIRES STANDARDS

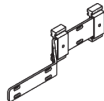
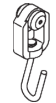
	SG 6070 Corde ø 6 mm
	SG 6086 Ressort d'arrêt delrin
	SG 6098 Rouleur
	SG 6214 Conducteur réglable
	SG 6227 Conducteur
	SG 6371 Profil
	SG 6377 Set poulies
	SG 10731 Poulie de sécurité pour chaînette & cordon

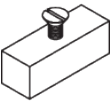
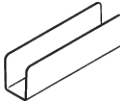
B. ACCESSOIRES EN OPTION

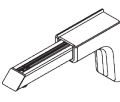
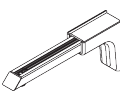
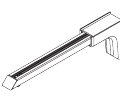
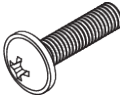
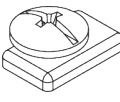
	SG 3582 Agrafe Delrin
	SG 6053 Ressort d'arrêt
	SG 6079 Chariot croisant
	SG 6094 Rouleur
	SG 6283 Rouleur
	SG 6369 Ecrou
	SG 6376 Pièce de raccord
	SG 6575 Tendeur pour corde
	SG 6578 Fixation au sol
	SG 11154 Universal Smart Fix 120 mm
	SG 11155 Universal Smart Fix 150 mm
	SG 11156 Universal Smart Fix 200 mm
	SG 11157 Vis M5x20
	SG 11295 Arrêt

Les architectes du silence

Silent Gliss est le premier fournisseur mondial d'équipements de protection visuelle et solaire d'intérieur de haute qualité. Depuis 1952, l'emploi des technologies les plus récentes ainsi que les efforts inlassables de recherche de précision permettent de mettre au point en Suisse des systèmes de rideaux plus silencieux et simples à utiliser que n'importe quel autre système au monde.

Pour répondre aux besoins de nos clients, nous proposons des produits fonctionnels et sans entretien, faits sur mesure. Des conseils techniques d'experts dans le domaine résidentiel et commercial ainsi que des services d'installation et d'assistance complètent notre gamme. Silent Gliss privilégie toujours les solutions sur mesure innovantes, pratiques et durables, d'un design exceptionnel et d'une qualité supérieure.

Silent Gliss Benelux

België – Belgique

T +32 2 240 03 60

F +32 2 240 03 69

info@silentgliss.be

silentgliss.be

silentgliss.nl