

SG 4780

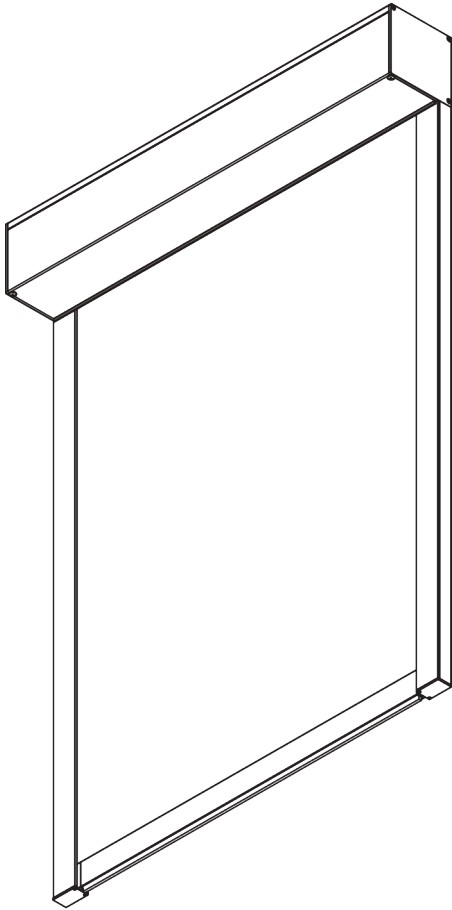
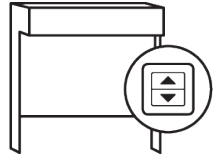

INFORMATION PRODUIT

- **Mode de commande:** Motorisé
- **Gamme:** L
- **Installation:** Plafond, Murale, Encastré
- **Couleurs:** Blanc RAL 9016, Noir RAL 9005, couleurs spéciales possible
- **Tissus:** Se référer à la collection tissu Silent Gliss

Caractéristiques:

- Technologie ZIP
- Moteurs rapide et silencieux
- Fin de courses lente
- Plusieurs options de commandes
- Glissière de guidage de 40mm, prépercée

04/2024/V3

SPÉCIFICATION SYSTÈME

A. DIMENSIONS SYSTÈME



3 m



65 cm*

*se référer au tableau des
moteurs

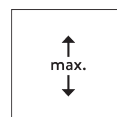

3 m

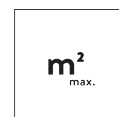

9 m²



6 kg

B. PROFIL

Information profil

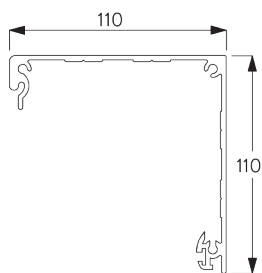

SG 10998

Boîtier 110 mm

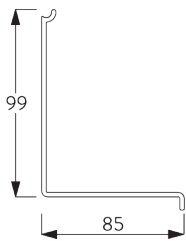

SG 10999

Couvercle 110 mm

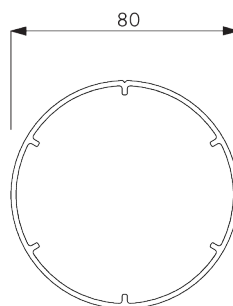

SG 11003

Profil ø 80 mm

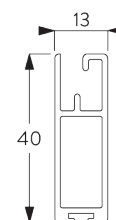

SG 10993

Barre de lestage rectangulaire

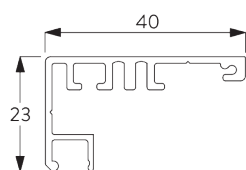

SG 11418

Profil de guidage

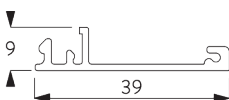

SG 11419

Couvercle de guidage

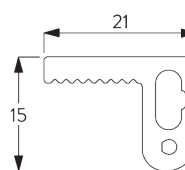

SG 11421

Profil Zip

C. PRISE DE MESURE

Installation en tableau

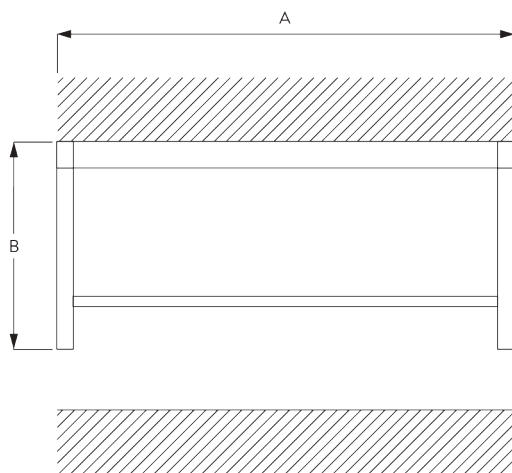

A : Largeur du système
B : Hauteur du système

Fixation murale

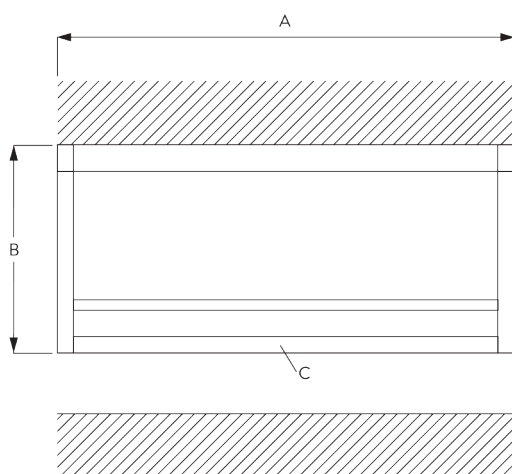

A : Largeur du système
B : Hauteur du système
C : Option profil bas (SG 11418 / SG 11419)

INSTALLATION

A. INSTRUCTION DE POSE

Pour des informations détaillées, se référer au site web Silent Gliss.

Points de fixation en pose tableau

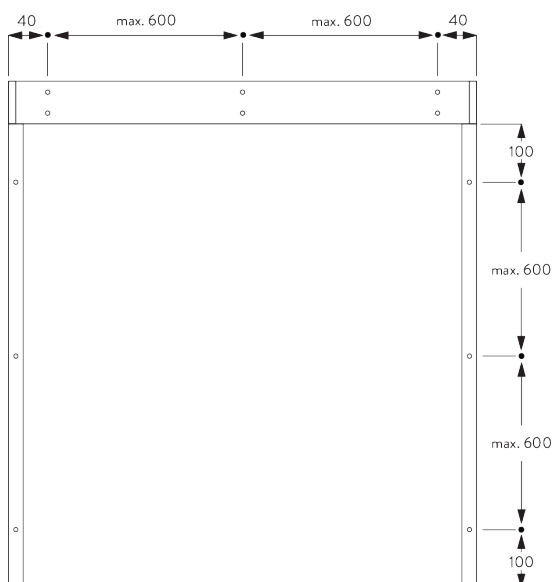

Points de fixation en pose murale

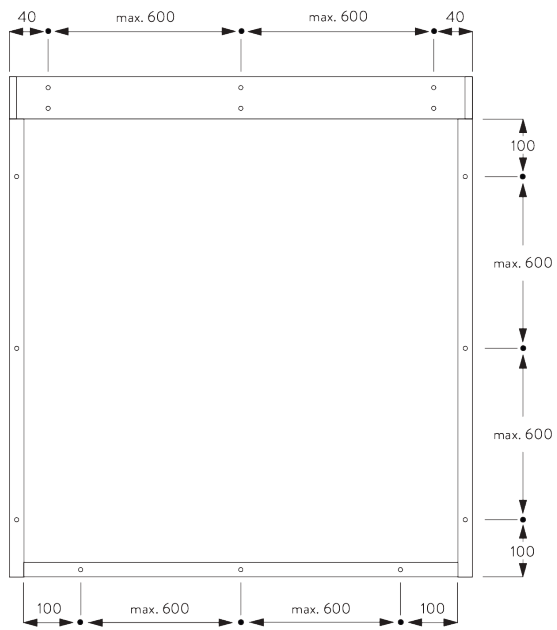

B. FIXATION PLAFOND

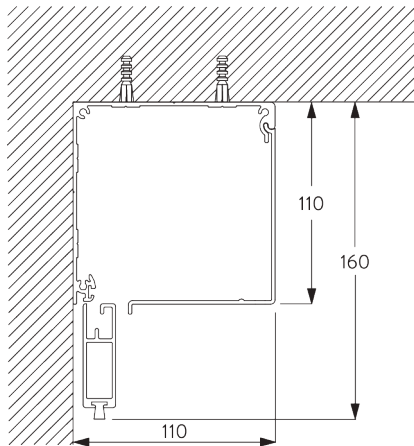

C. FIXATION MURALE

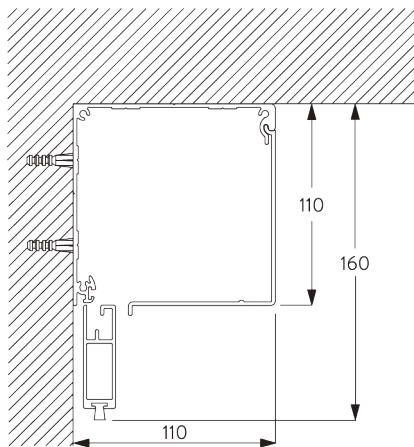

D. FIXATION
ENCASTRÉE

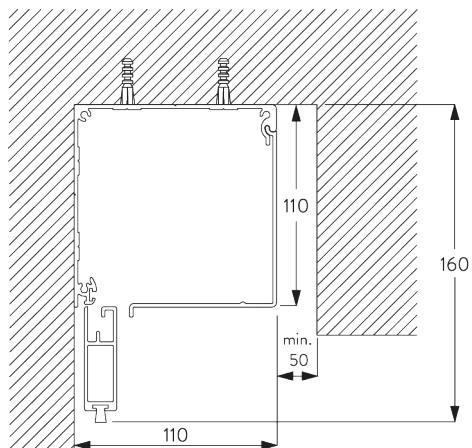

E. GLISSIÈRES DE
GUIDAGE
SG 11418 / SG 11419

Fixation en tableau

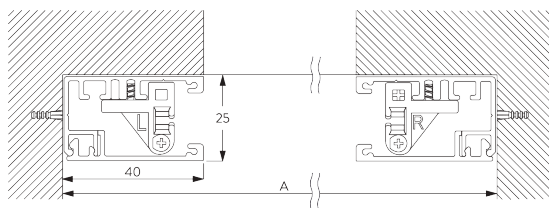

A: Largeur système

Fixation murale

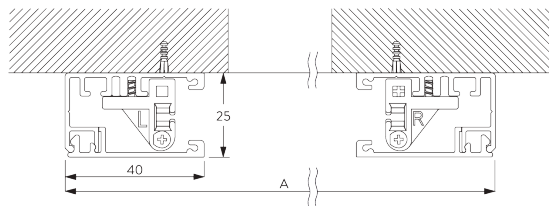

A: Largeur système

MOTEURS ET CONTRÔLES

A. CARACTÉRISTIQUES MOTEURS

Moteurs	Série 50	Série 20	Série 20	Série 10 K	Série 5
	SG 11251	SG 10523	SG 10522	SG 10514	SG 10715

Caractéristiques moteurs

Fin de course souple	•	•	•		
Fin de course électronique	•	•	•		
Compteur électronique de révolution moteurs (illimité)	•	•	•		
Fin de course mécanique				•	•
Compteur mécanique de révolution moteurs (limité)				•	•
Deux fins de course intermédiaires possibles		•			
Barre de lestage alignement	•				
Arrêt moteur silencieux		•	•	•	
Branchement en parallèle possible sans relais		•	•		
Fiche de raccord moteur démontable	•	•	•		
Classe IP	IP 30	IP 44	IP 44	IP 44	IP 44

Caractéristiques de contrôle

Contrôle moteur via l'alimentation principale		•	•	•	•
SG Control L (récepteur radio intégré)		•			
Smart by Silent Gliss	•				
Compatible avec les systèmes automates classiques (avec l'interface adéquate)		•	•	•	•

B. SPÉCIFICATIONS MOTEURS

Voir le site Web pour le schéma de câblage.

Moteurs	Largeur mini système	Voltage	Ampérage	Fréquence	Vitesse	Fréquence récepteur
Série 50 (Smart by Silent Gliss)						
SG 11251	65 cm	24 V DC	1.5 A	-	32 rpm	-
Série 20						
SG 10522 (Standard)	65 cm	230 V AC	0.55 A	50 Hz	30 rpm	-
SG 10523	65 cm	230 V AC	0.55 A	50 Hz	30 rpm	868/915 MHz
Série 10 K						
SG 10514	65 cm	230 V AC	0.52 A	50 Hz	30 rpm	-
Série 5						
SG 10715	65 cm	230 V AC	0.485 A	50-60 Hz	28 rpm	-

C. MODE DE COMMANDE

Se référer au catalogue "Contrôles" pour des informations.

Inverseur mural



Le système peut être commandé par un inverseur mural.

SG Control L



Plusieurs télécommandes manuelles et murales disponibles.



Application Silent Gliss Move.

Smart by Silent Gliss



Système de communication bidirectionnel de conception ouverte qui permet d'intégrer parfaitement les produits à la plupart des principaux systèmes de contrôle domestique.











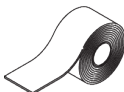

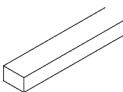
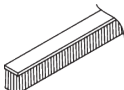

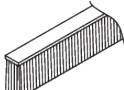

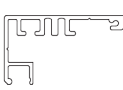



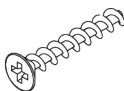
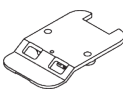



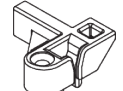

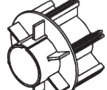
D. PLANS DE BRANCHEMENT

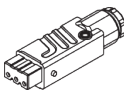
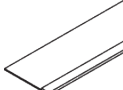
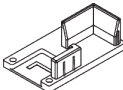

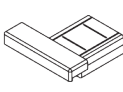
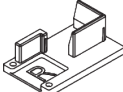
Se référer au site web Silent Gliss.

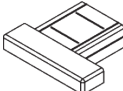
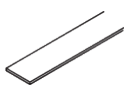
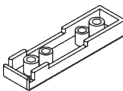
ACCESSOIRES

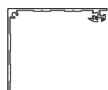
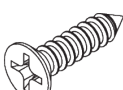
A. ACCESSOIRES STANDARDS

	SG 4226 Bande adhésif 30 mm		SG 11003 Profil ø 80 mm		SG 11060 Ruban adhésif
	SG 4508 Brosse 5x7		SG 11008 Embout boîtier gauche 110 mm		SG 11324 Vis KA35x14
	SG 4509 Brosse 5x12		SG 11009 Embout boîtier droit 110 mm		SG 11418 Profil de guidage
	SG 6791 Vis 3.9x32		SG 11011 Clip support		SG 11419 Couvercle de guidage
	SG 6933 Vis KA25x16		SG 11013 Clip moteur		SG 11421 Profil Zip
	SG 6936 Vis KA22x10		SG 11020 Adaptateur suport tube 80mm		SG 11473 Embout guide Zip gauche
	SG 6942 Vis KA30x8		SG 11022 Adaptateur tube 80mm moteur		SG 11474 Embout guide Zip droite
	SG 9917 Fiche raccordement male		SG 11025 Bande Zip		SG 11475 Embout profil guidage gauche
	SG 10284 Anneau		SG 11028 Embout barre de lestage gauche		SG 11476 Embout profil guidage droite
	SG 10522 Moteur 230V AC, série 20 S 3/30		SG 11029 Embout barre de lestage droite		
	SG 10668 Bande adhésif 10 mm		SG 11030 Cache barre de lestage		
	SG 10993 Barre de lestage rectangulaire		SG 11034 Vis 3.5x16		
	SG 10998 Boîtier 110 mm		SG 11035 Vis 2.2x9.5		
	SG 10999 Couvercle 110 mm		SG 11059 Vis M4x12		

B. ACCESSOIRES EN OPTION

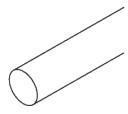

SG 4951

Contrepoids acier

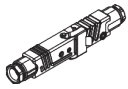

SG 9916

Hirschmann Kit d'accouplement



SG 10293

Câble de branchement moteur - 3, 5 et 10 m en option



SG 10300

Télécommande radio 1 canal



SG 10302

Télécommande radio 5 canaux + 1 générale



SG 10303

Télécommande radio 10 canaux 2 sous groupes 1 générale

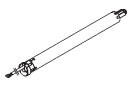

SG 10514

Moteur 230V AC, série 10 S 3/30 K



SG 10523

Moteur 230V AC, série 20 S 3/30, récepteur radio



SG 10715

Moteur 230V AC, série 5 S 6/28



SG 10804

Télécommande radio 15 canaux + 5 canaux + 1 Groupé

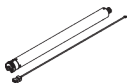

SG 11251

Moteur 24V DC, 50-Series S 3/32

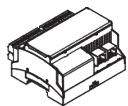

SG 11260

Gateway Cedia

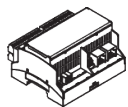

SG 11261

Gateway KNX

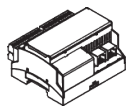

SG 11262

Module d'extension

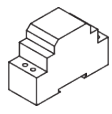

SG 11263

Alimentation 24V DC, 2.5A Rail DIN

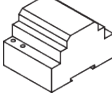

SG 11264

Alimentation 24V DC, 3.8A Rail DIN

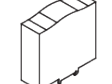

SG 11265

Alimentation 24V DC, 5A Rail DIN

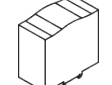

SG 11266

Alimentation 24V DC, 10A Rail DIN

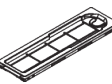

SG 11460

Cache pour Hirschmann prise de courant



SG 11480

Télécommande radio murale 1 canal



SG 11490

Télécommande radio murale 5+1 canaux

