

SG 6243

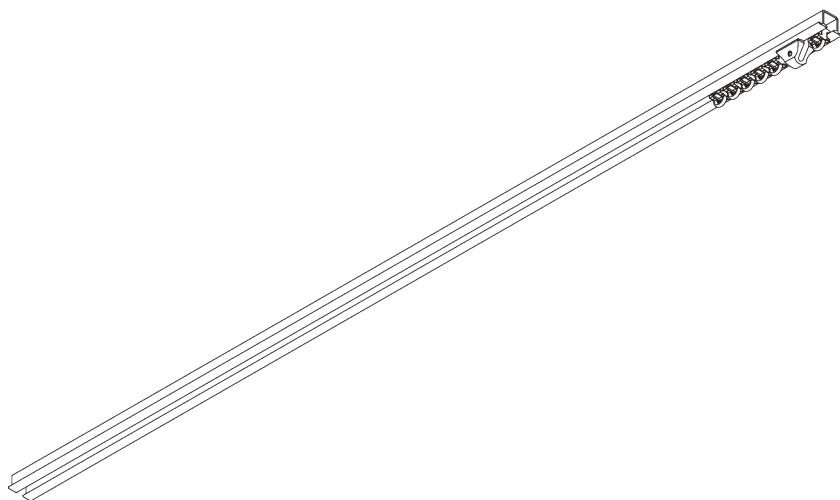

INFORMATION PRODUIT

- **Mode de commande:** Tirage main
- **Gamme:** S - M
- **Installation:** Encastrée
- **Couleurs:** Blanc RAL 9016 ou Aluminium, couleurs spéciales possibles
- **Tissus:** Se référer à la collection tissu Silent Gliss

Caractéristiques:

- Glisseur Bi-composants
- Option glisseur Wave Bi-composants
- Profil pré-percé
- Cintrable

SPÉCIFICATION SYSTÈME

A. PROFIL

Profil et information de cintrage

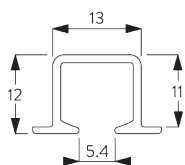

SG 6243p

Profil

Rayon:
✓ 20 cm, >25 cm

B. PRISE DE MESURE

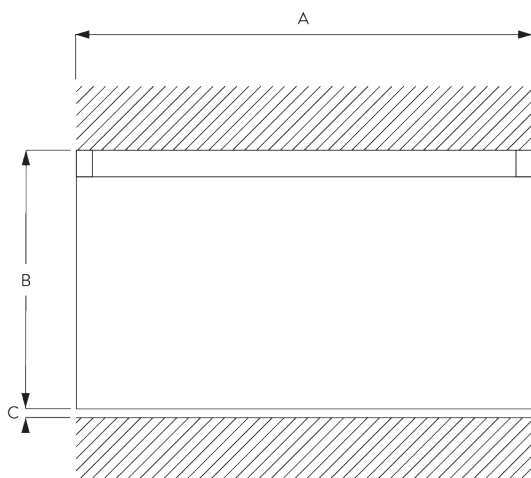

A: Largeur système

B: Hauteur système

C: Distance entre bas du rideau et le sol

INSTALLATION

A. INSTRUCTION DE POSE

Pour des informations détaillées, se référer au site web Silent Gliss.

Points de fixation

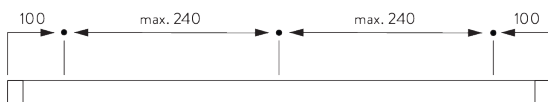

B. FIXATION ENCASTRÉE

Fixation directe dans le bois

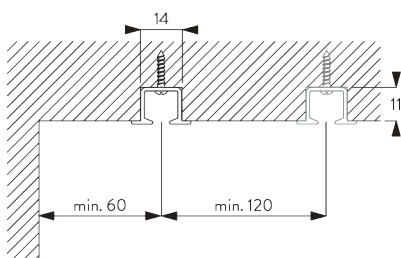

Rainure d'encastrement: 11 x 14 mm

OPTIONS SYSTÈME

A. WAVE

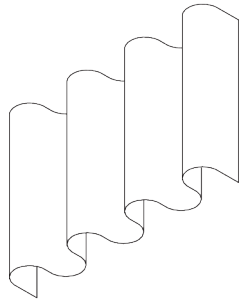

SG 11295

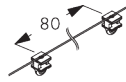

SG 11302



SG 2255



SG 2256

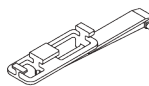

SG 6364



SG 6365

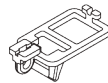

SG 6366

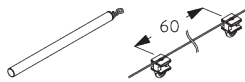

SG 10430-34 SG 11303



SG 3582

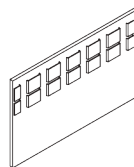

SG 6349

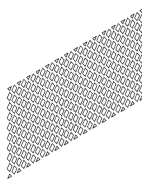

SG 6363

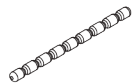

SG 10075



SG 10076

Composants standard:

- SG 11295 Vis d'arrêt
- SG 11302 Glisseurs Wave bi-composants 80 mm

Composants en option (rayon >25 cm):

- SG 2255 Frein
- SG 2256 Frein
- SG 6364 Extension Wave
- SG 6365 Crochet Wave
- SG 6366 Chariot Wave pour lance rideau
- SG 10430-34 Lance rideau
- SG 11303 Glisseur Wave bi-composants 60 mm

Composants de rideaux:

- SG 3582 Crochet
- SG 6349 Ruban Wave transparent
- SG 6363 Ruban à repasser
- SG 10075 Fil à plomb 50 gr/m
- SG 10076 Barre de lestage

Paquet rideau Wave - Glisseur Bi-composants (standard)

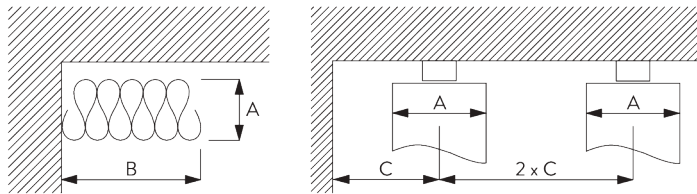

A = Epaisseur du Wave
 B = Largeur paquet rideau
 C = Ecartement minimum

Glisseur Bi-composants SG 11302	Nombre de poches entre crochets	Ampleur rideau Approximative	Epaisseur du Wave A	Largeur paquet rideau B*	Ecartement minimum C
80	6	~2.1	140	180 mm par ml de tringle	90
80	7	~2.3	160	180 mm par ml de tringle	100

Glisseur Bi-composants SG 11303	Nombre de poches entre crochets	Ampleur rideau Approximative	Epaisseur du Wave A	Largeur paquet rideau B*	Ecartement minimum C
60	4	~2.1	100	230 mm par ml de tringle	70
60	5	~2.3	120	230 mm par ml de tringle	80

**Largeur paquet rideau B lors de l'utilisation du bras d'extension SG 6364 augmente de 150 mm par rideau!*

ACCESSOIRES

A. ACCESSOIRES STANDARDS



SG 6065
Fixateur avec oeillet

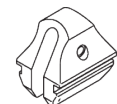

SG 6086
Ressort d'arrêt delrin



SG 6243p
Profil



SG 10717
Vis 2.2x19



SG 11300
Glisseur Bi-composants

B. ACCESSOIRES EN OPTION

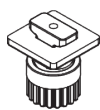

SG 2255
Frein

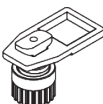

SG 2256
Frein

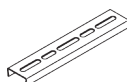

SG 3067
Pièce de raccord



SG 3582
Agrafe Delrin



SG 6053
Ressort d'arrêt



SG 6094
Rouleau



SG 6098
Rouleau



SG 6283
Rouleau



SG 6349
Ruban Wave transparent

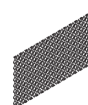

SG 6363
Ruban à repasser

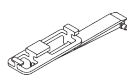

SG 6364
Extension

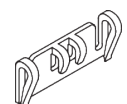

SG 6365
Crochet Wave

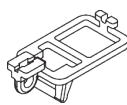

SG 6366
Chariot pour lance rideau

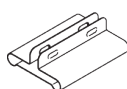

SG 7002
Protecteur de profil

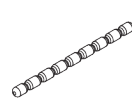

SG 10075
Fil à plomb 50 gr/m

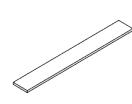

SG 10076
Barre de lestage



SG 10430
Lance rideau aluminium avec crochet, 50cm

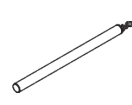

SG 10431
Lance rideau aluminium avec crochet, 75 cm

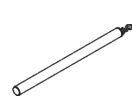

SG 10432
Lance rideau aluminium avec crochet, 100 cm

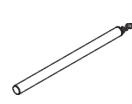

SG 10433
Lance rideau aluminium avec crochet, 125 cm

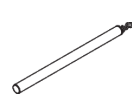

SG 10434
Lance rideau aluminium avec crochet, 150 cm

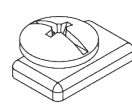

SG 11295
Arrêt



SG 11301
Glisseur Bi-composants en barrette

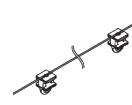

SG 11302
Glisseur Wave Bi-composants 80 mm



SG 11303
Glisseur Wave Bi-composants 60 mm

