

SG 6250

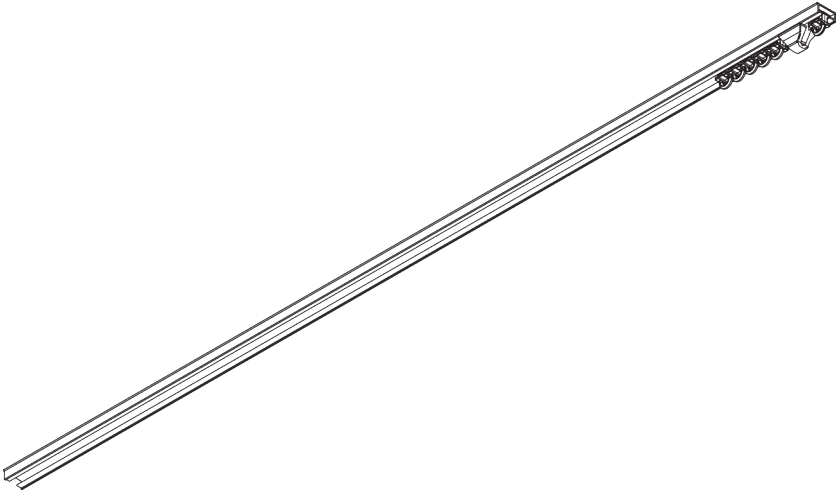

INFORMATION PRODUIT

- **Mode de commande:** Tirage main
- **Gamme:** S - M
- **Installation:** Encastrée
- **Couleurs:** Blanc RAL 9016
- **Tissus:** Se référer à la collection tissu Silent Gliss

Caractéristiques:

- Glisseur Bi-composants
- Option glisseur Wave Bi-composants
- Cintrable

SPÉCIFICATION SYSTÈME

A. PROFIL

Profil et information de cintrage

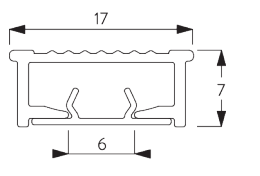

SG 11220

Profil avec protection

✓ Rayon:
10 cm, 20 cm

B. PRISE DE MESURE

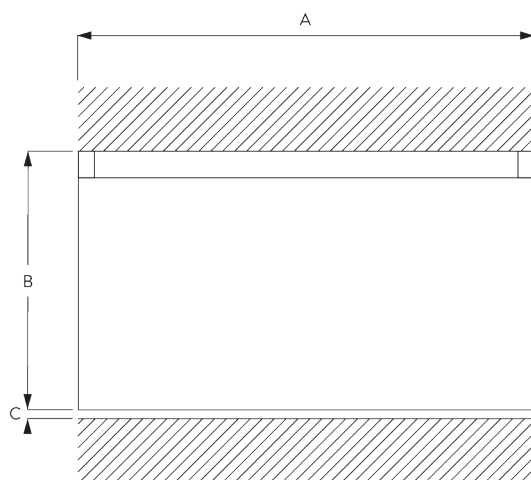

A: Largeur système

B: Hauteur système

C: Distance entre bas du rideau et le sol

INSTALLATION

A. INSTRUCTION DE POSE

Pour des informations détaillées, se référer au site web Silent Gliss.

B. FIXATION PLAFOND ENCASTRÉE

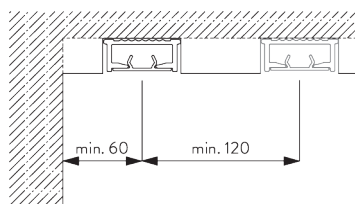

Assemblage adhésif exclusivement sur béton brut.

OPTIONS SYSTÈME

A. WAVE

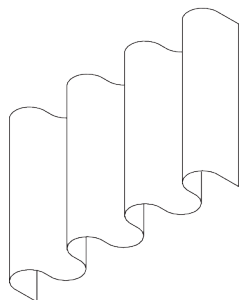

SG 11295

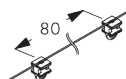

SG 11302

Composants standard:

- SG 11295 Vis d'arrêt
- SG 11302 Glisseurs Wave bi-composants 80 mm

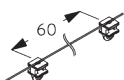

SG 11303

Composants en option:

- SG 11303 Glisseur Wave bi-composants 60 mm



SG 3582

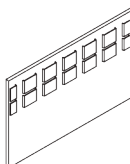

SG 6349

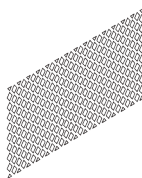

SG 6363

Composants de rideaux:

- SG 3582 Crochet
- SG 6349 Ruban Wave transparent
- SG 6363 Ruban à repasser
- SG 10075 Fil à plomb 50 gr/m
- SG 10076 Barre de lestage

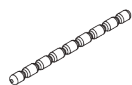

SG 10075

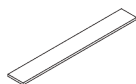

SG 10076

Paquet rideau Wave - Glisseur Bi-composants (standard)

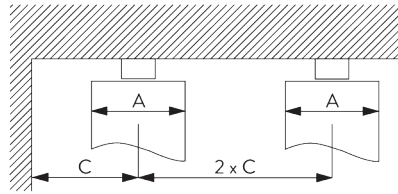
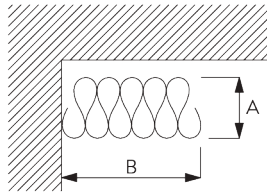

A = Epaisseur du Wave
 B = Largeur paquet rideau
 C = Ecartement minimum

Glisseur Bi-composants SG 11302	Nombre de poches entre crochets	Ampleur rideau Approximative	Epaisseur du Wave A	Largeur paquet rideau B*	Ecartement minimum C
80	6	~2.1	140	180 mm par ml de tringle	90
80	7	~2.3	160	180 mm par ml de tringle	100

Glisseur Bi-composants SG 11303	Nombre de poches entre crochets	Ampleur rideau Approximative	Epaisseur du Wave A	Largeur paquet rideau B*	Ecartement minimum C
60	4	~2.1	100	230 mm par ml de tringle	70
60	5	~2.3	120	230 mm par ml de tringle	80

ACCESSOIRES

A. ACCESSOIRES STANDARDS



SG 6065
Fixateur avec oeillet

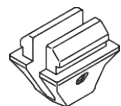

SG 6245
Ressort d'arrêt



SG 11220
Profil avec protection

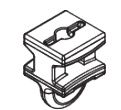

SG 11300
Glisseur Bi-composants

B. ACCESSOIRES EN OPTION



SG 3582
Agrafe Delrin



SG 6349
Ruban Wave transparent



SG 6363
Ruban à repasser



SG 10075
Fil à plomb 50 gr/m

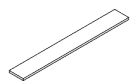

SG 10076
Barre de lestage

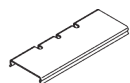

SG 11222
Pièce de raccord

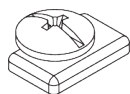

SG 11295
Arrêt



SG 11301
Glisseur Bi-composants en barrette

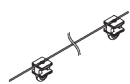

SG 11302
Glisseur Wave Bi-composants 80 mm

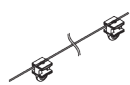

SG 11303
Glisseur Wave Bi-composants 60 mm

