

SG 6870

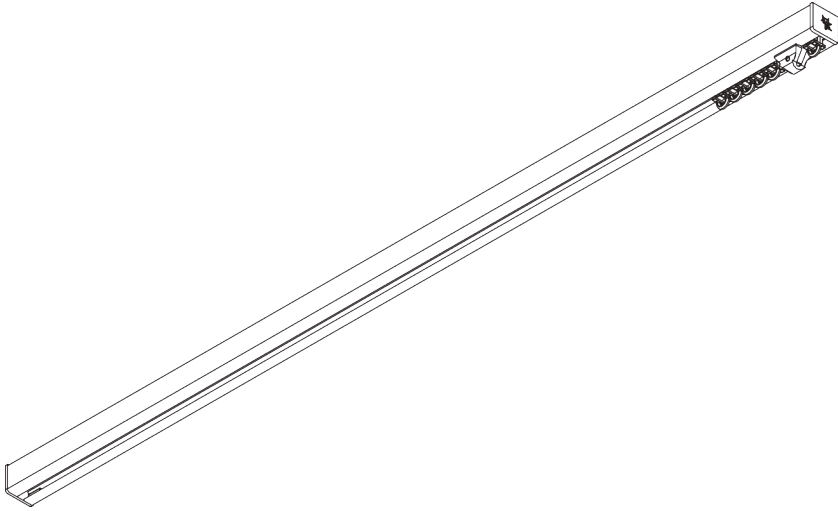

INFORMATION PRODUIT

- **Mode de commande:** Tirage main
- **Gamme:** M - L
- **Installation:** Plafond, murale, encastrée
- **Couleurs:** Blanc RAL 9016, Noir RAL 9005 ou Aluminium, couleurs spéciales possibles (profil d'encastrement uniquement en Blanc RAL 9016, Noir RAL 9005 ou couleur spéciale)
- **Tissus:** Se référer à la collection tissu Silent Gliss

Caractéristiques:

- Glisseurs Bi-Composants
- Option Glisseurs Wave Bi-Composants
- Cintrable
- Cintrable avec profil d'encastrement

SPÉCIFICATION SYSTÈME

A. PROFIL

Profil et information de cintrage

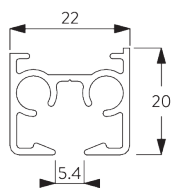

SG 11190

Profil

✓ Rayon: >26 cm

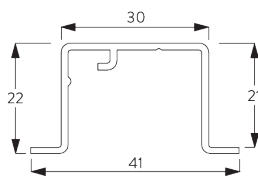

SG 11230

Profil d'encastrement

✓ Rayon: >50 cm

B. PRISE DE MESURE

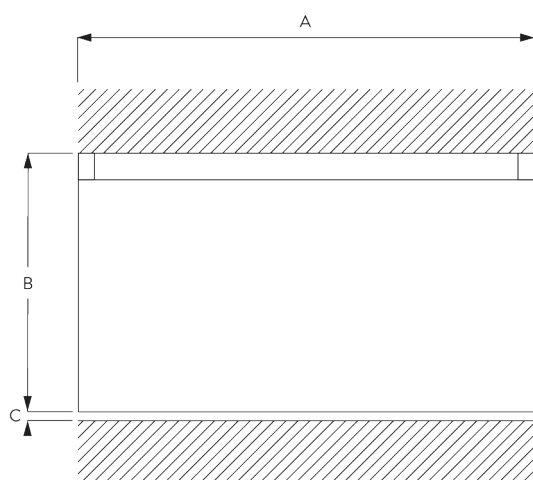

A: Largeur système

B: Hauteur système

C: Distance entre bas du rideau et le sol

INSTALLATION

A. INSTRUCTION DE POSE

Pour des informations détaillées, se référer au site web *Silent Gliss*.

Points de fixation

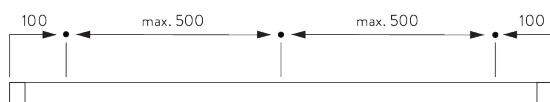

B. FIXATION PLAFOND

Bride SG 3825

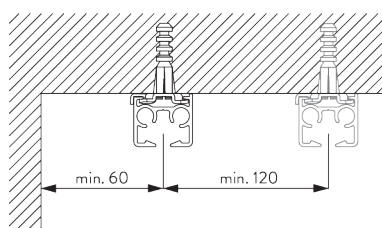

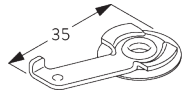

SG 3825

Bride

Support SG 3826

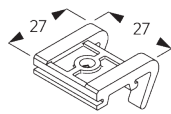
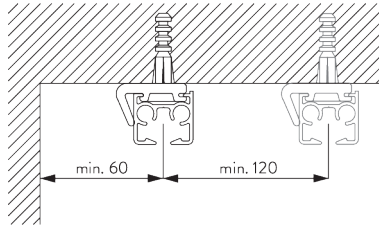

SG 3826

Support

Support SG 3832

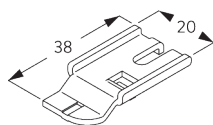
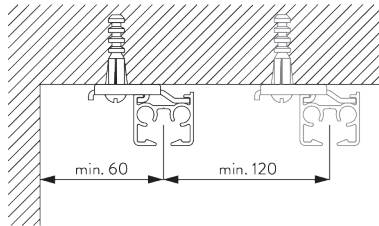

SG 3832

Support

**C. FIXATION
MURALE**

Smart Fix

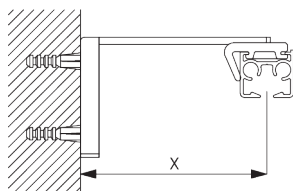

Smart Fix SG 11200 - SG 11205 et support SG 3826:

Vis SG 10492 (M4x8) nécessaire.

Smart Fix	X mm (SG 3826 / SG 3825)	X mm (SG 3832)
SG 11200 / SG 11210	52	70
SG 11201 / SG 11211	72	90
SG 11202 / SG 11212	92	110
SG 11203 / SG 11213	112	130
SG 11204 / SG 11214	142	160
SG 11205 / SG 11215	192	210
SG 11154	102 - 130	120 - 148
SG 11155	132 - 160	150 - 178
SG 11156	182 - 210	200 - 228

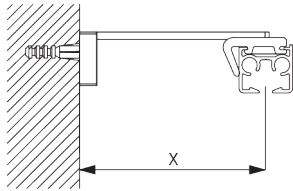

Square Smart Fix SG 11210 - SG 11215
et support SG 3826:
 Vis SG 10492 (M4x8) nécessaire.

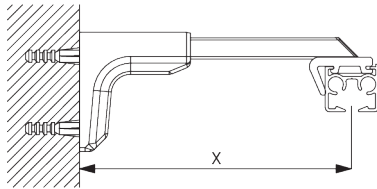

Universal Smart Fix SG 11154 - SG 11156
et support SG 3826:
 Vis SG 10277 (M4x12) nécessaire.

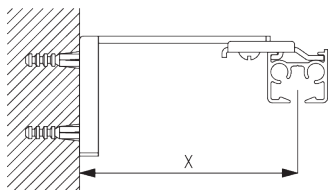

Smart Fix SG 11200 - SG 11205 et support SG 3832:
 Vis SG 10492 (M4x8) nécessaire.

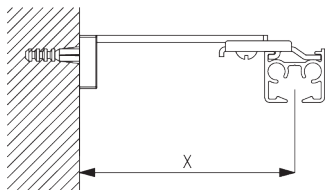

Square Smart Fix SG 11210 - SG 11215
et support SG 3832:
 Vis SG 10492 (M4x8) nécessaire.

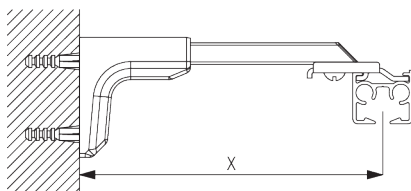

Universal Smart Fix SG 11154 - SG 11156
et support SG 3832:
 Vis SG 10407 (M4x10) nécessaire.

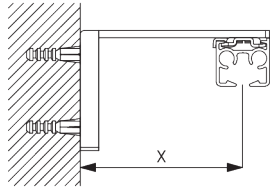

Smart Fix SG 11200 - SG 11205 et bride SG 3825:
Vis SG 10074 (M4x8) nécessaire.

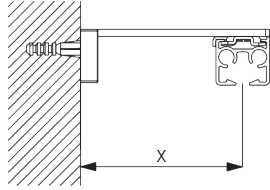

Square Smart Fix SG 11210 - SG 11215 et bride SG 3825:
Vis SG 10074 (M4x8) nécessaire.

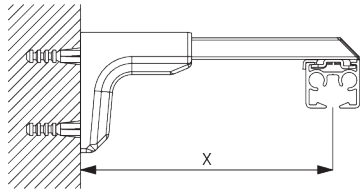

Universal Smart Fix SG 11154 - SG 11156 et bride SG 3825:
Vis SG 11158 (M4x12) nécessaire.

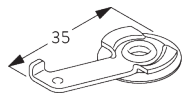

SG 3825
Bride

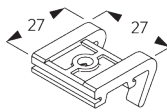

SG 3826
Support

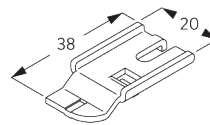

SG 3832
Support



SG 10074
Vis M4x8



SG 10277
Vis M4x12



SG 10407
Vis M4X10



SG 10492
Vis M4x8



SG 11158
Vis M4x12

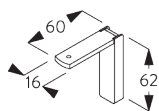

SG 11200
Smart Fix 60 mm

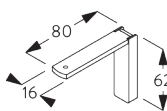

SG 11201
Smart Fix 80 mm

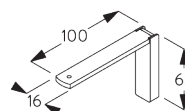

SG 11202
Smart Fix 100 mm

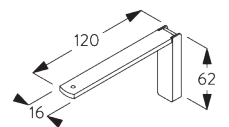

SG 11203
Smart Fix 120 mm

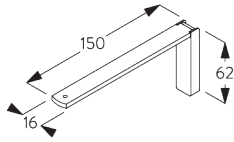

SG 11204

Smart Fix 150 mm

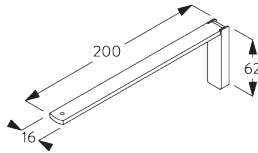

SG 11205

Smart Fix 200 mm

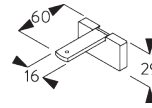

SG 11210

Square Smart Fix 60 mm

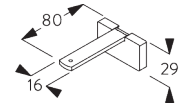

SG 11211

Square Smart Fix 80 mm

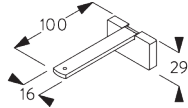

SG 11212

Square Smart Fix 100 mm

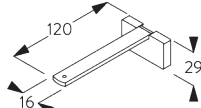

SG 11213

Square Smart Fix 120 mm

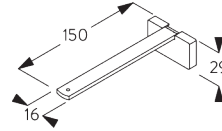

SG 11214

Square Smart Fix 150 mm

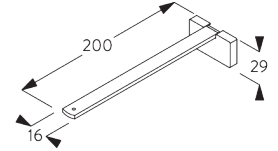

SG 11215

Square Smart Fix 200 mm

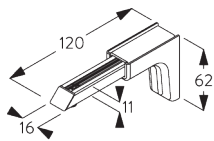

SG 11154

Universal Smart Fix 120 mm

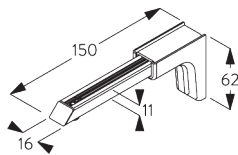

SG 11155

Universal Smart Fix 150 mm

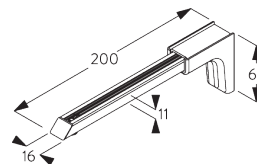

SG 11156

Universal Smart Fix 200 mm

Support SG 3836

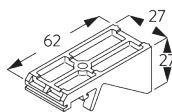
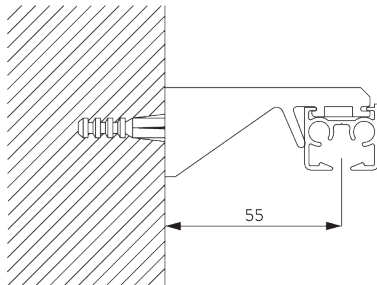

SG 3836

Support

D. FIXATION ENCASTREE

Profil d'encastrement SG 11230

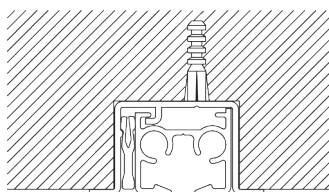

Une cale de blocage SG 10157 par point de fixation.
Pour les détails d'une installation encastrée, se référer au site Silent Gliss.

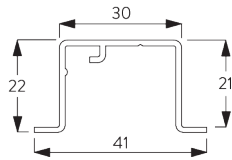

SG 11230
Profil d'encastrement

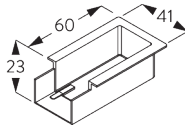

SG 11238
Masque profil encastrement

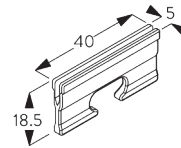

SG 10157
Clip blocage pour profil d'encastrement

OPTIONS SYSTÈME

A. WAVE

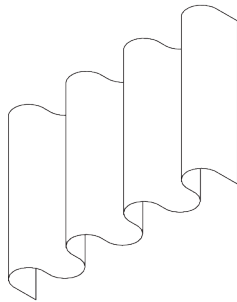

SG 11295

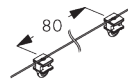

SG 11302



SG 2255



SG 2256

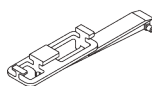

SG 6364



SG 6365

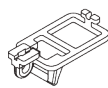

SG 6366

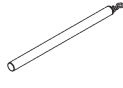

SG 10430-34

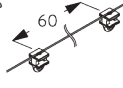

SG 11303

Composants Standards:

- SG 11295 Vis d'arrêt
- SG 11302 Glisseurs Wave bi-composants 80 mm

Composants en option:

- SG 2255 Frein
- SG 2256 Frein
- SG 6364 Extension Wave
- SG 6365 Crochet Wave
- SG 6366 Chariot Wave pour lance rideau
- SG 10430-34 Lance rideau
- SG 11303 Glisseur Wave bi-composants 60 mm

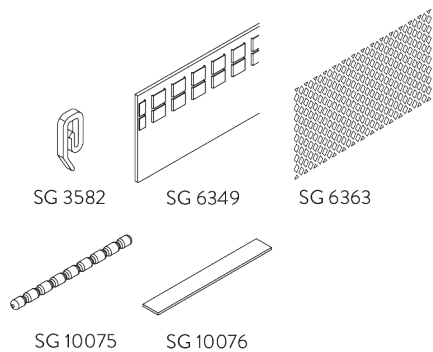

Composants de rideaux:

- SG 3582 Crochet
- SG 6349 Ruban Wave transparent
- SG 6363 Ruban à repasser
- SG 10075 Fil à plomb 50 gr/m
- SG 10076 Barre de lestage

Paquet rideau Wave - Glisseur Bi-composants (standard)

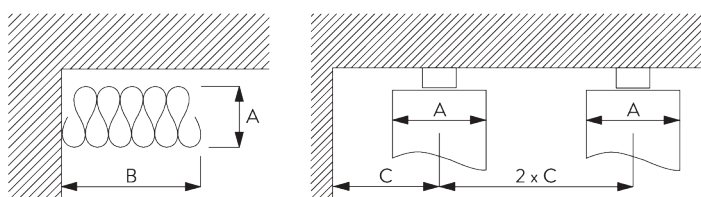

A = Epaisseur du Wave
 B = Largeur paquet rideau
 C = Ecartement minimum





Glisseur Bi-composants SG 11302	Nombre de poches entre crochets	Ampleur rideau Approximative	Epaisseur du Wave A	Largeur paquet rideau B*	Ecartement minimum C
80	6	~2.1	140	180 mm par ml de tringle	90
80	7	~2.3	160	180 mm par ml de tringle	100

Glisseur Bi-composants SG 11303	Nombre de poches entre crochets	Ampleur rideau Approximative	Epaisseur du Wave A	Largeur paquet rideau B*	Ecartement minimum C
60	4	~2.1	100	230 mm par ml de tringle	70
60	5	~2.3	120	230 mm par ml de tringle	80





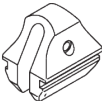
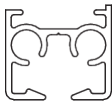
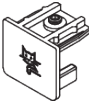





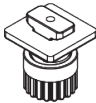
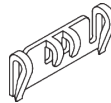
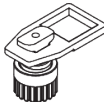
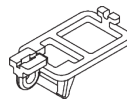

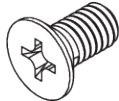

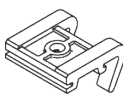
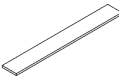
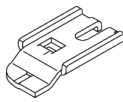
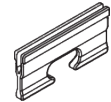
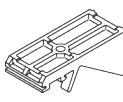

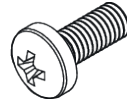
*Largeur paquet rideau B lors de l'utilisation du bras d'extension SG 6364 augmente de 150 mm par rideau!

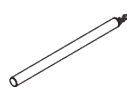
ACCESSOIRES

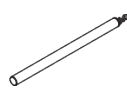
A. ACCESSOIRES STANDARDS

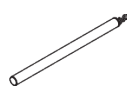
	SG 3825 Bride
	SG 6065 Fixateur avec oeillet
	SG 6086 Ressort d'arrêt delrin
	SG 11190 Profil
	SG 11233 Embout
	SG 11300 Glisseur Bi-composants

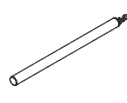
B. ACCESSOIRES EN OPTION

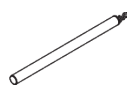
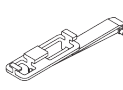
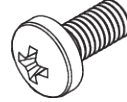
	SG 2255 Frein		SG 6365 Crochet Wave
	SG 2256 Frein		SG 6366 Chariot pour lance rideau
	SG 3582 Agrafe Delrin		SG 10074 Vis M4x8
	SG 3802 Pièce de raccord		SG 10075 Fil à plomb 50 gr/m
	SG 3826 Support		SG 10076 Barre de lestage
	SG 3832 Support		SG 10157 Clip blocage pour profil d'encastrement
	SG 3836 Support		SG 10277 Vis M4x12
	SG 6053 Ressort d'arrêt		SG 10407 Vis M4X10
	SG 6094 Rouleur		SG 10430 Lance rideau aluminium avec crochet, 50cm
	SG 6098 Rouleur		SG 10431 Lance rideau aluminium avec crochet, 75 cm
	SG 6283 Rouleur		SG 10432 Lance rideau aluminium avec crochet, 100 cm
	SG 6349 Ruban Wave transparent		SG 10433 Lance rideau aluminium avec crochet, 125 cm
	SG 6363 Ruban à repasser		SG 10434 Lance rideau aluminium avec crochet, 150 cm
	SG 6364 Extension		SG 10492 Vis M4x8

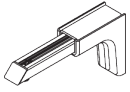

SG 11154
Universal Smart Fix 120 mm

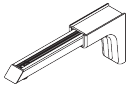

SG 11155
Universal Smart Fix 150 mm

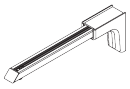

SG 11156
Universal Smart Fix 200 mm

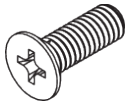

SG 11158
Vis M4x12

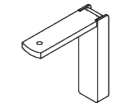

SG 11200
Smart Fix 60 mm

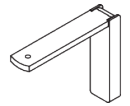

SG 11201
Smart Fix 80 mm

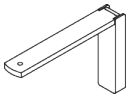

SG 11202
Smart Fix 100 mm

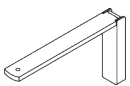

SG 11203
Smart Fix 120 mm

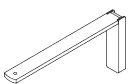

SG 11204
Smart Fix 150 mm

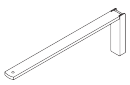

SG 11205
Smart Fix 200 mm

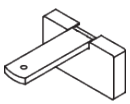

SG 11210
Square Smart Fix 60 mm

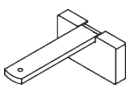

SG 11211
Square Smart Fix 80 mm

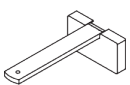

SG 11212
Square Smart Fix 100 mm

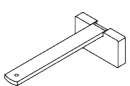

SG 11213
Square Smart Fix 120 mm

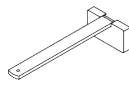

SG 11214
Square Smart Fix 150 mm

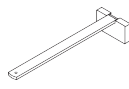

SG 11215
Square Smart Fix 200 mm

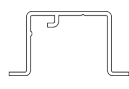

SG 11230
Profil d'encastrement

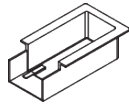

SG 11238
Masque profil encastrement

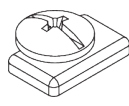

SG 11295
Arrêt



SG 11301
Glisseur Bi-composants en barrette

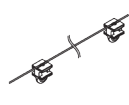

SG 11302
Glisseur Wave Bi-composants 80 mm

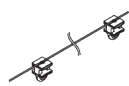

SG 11303
Glisseur Wave Bi-composants 60 mm

