

SG 6970

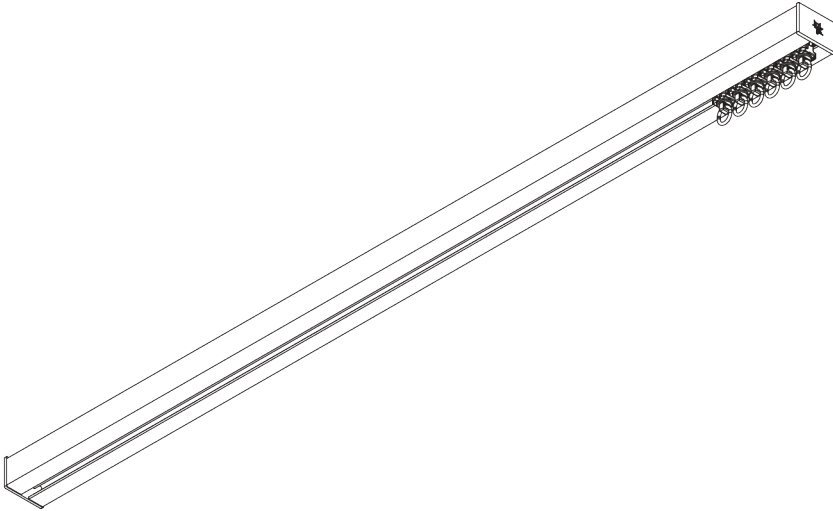
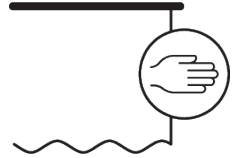

INFORMATION PRODUIT

- **Mode de commande:** Tirage main
- **Gamme:** M - L
- **Installation:** Plafond, murale, encastrée
- **Couleurs:** Blanc RAL 9016, Noir RAL 9005 ou Aluminium, couleurs spéciales possibles (profil d'encastrement uniquement en Blanc RAL 9016, Noir RAL 9005 ou couleur spéciale)
- **Tissus:** Se référer à la collection tissu Silent Gliss

Caractéristiques:

- Rouleurs Bi-Composants
- Option Rouleurs Wave Bi-Composants
- Cintrable
- Cintrable avec profil d'encastrement

SPÉCIFICATION SYSTÈME

A. PROFIL

Profil et information de cintrage

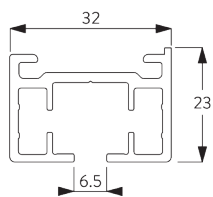

SG 10850

Profil

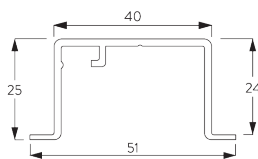

SG 10862

Profil d'encastrement

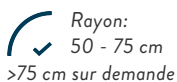

B. PRISE DE MESURE

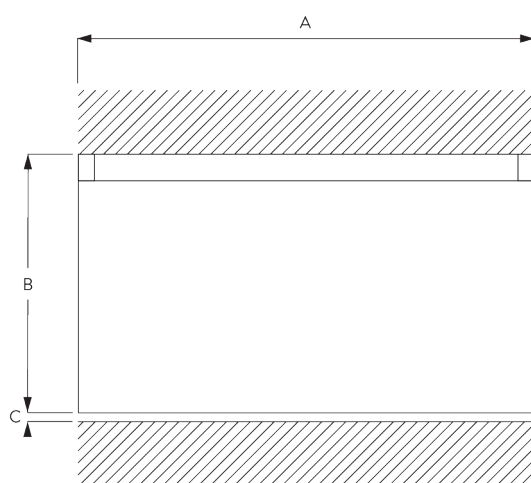

A: Largeur système

B: Hauteur système

C: Distance entre bas du rideau et le sol

INSTALLATION

A. INSTRUCTION DE POSE

Pour des informations détaillées, se référer au site web Silent Gliss.

Points de fixation

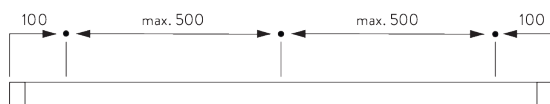

B. FIXATION
PLAFOND

Bride SG 3004

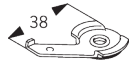
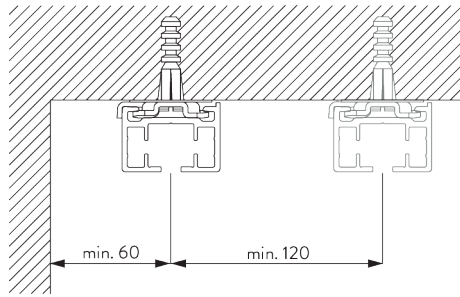

SG 3004

Bride

Fixation directe au
plafond

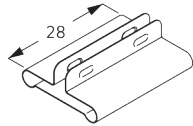
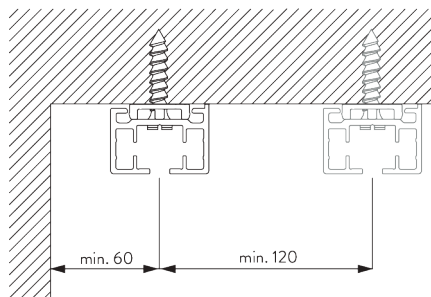

SG 7002

Protecteur de profil

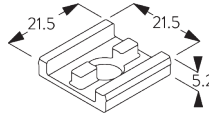

SG 10865

Clip pour montage

Support SG 3041

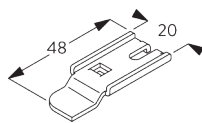
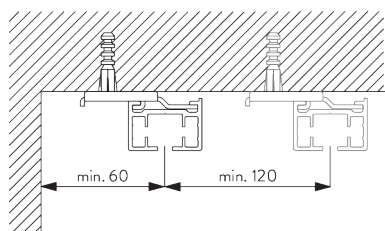

SG 3041

Support

C. FIXATION MURALE

Smart Fix

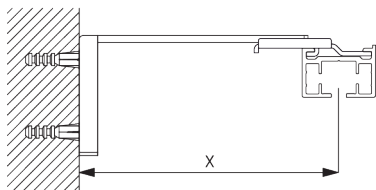

Smart Fix SG 11200 - SG 11205 et support SG 3041:
Vis SG 10492 (M4x8) nécessaire.

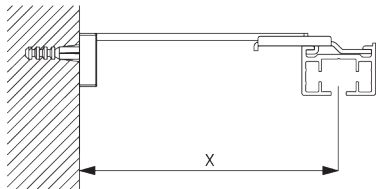

**Square Smart Fix SG 11210 - SG 11215
et support SG 3041:**
Vis SG 10492 (M4x8) nécessaire.

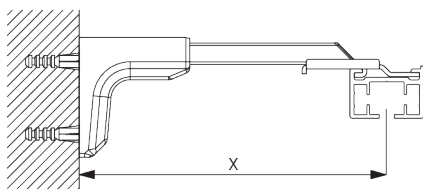

**Universal Smart Fix SG 11154 - SG 11156
et support SG 3041:**
Vis SG 10407 (M4x10) nécessaire.

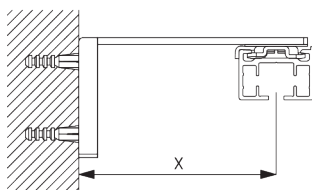

Smart Fix SG 11201 - SG 11205 et bride SG 3004:
Vis SG 10074 (M4x8) nécessaire.

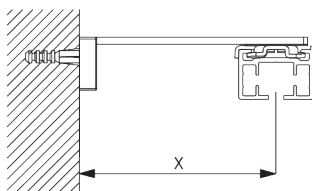

**Square Smart Fix SG 11211 - SG 11215
et bride SG 3004:**
Vis SG 10074 (M4x8) nécessaire.

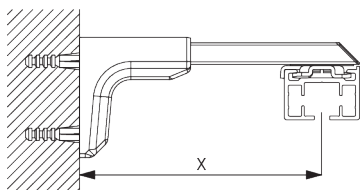

**Universal Smart Fix SG 11154 - SG 11156
et bride SG 3004:**
Vis SG 11158 (M4x12) nécessaire.

Smart Fix	X mm (SG 3041)	X mm (SG 3004)
SG 11200 / SG 11210	83	
SG 11201 / SG 11211	103	72
SG 11202 / SG 11212	123	92
SG 11203 / SG 11213	143	112
SG 11204 / SG 11214	173	142
SG 11205 / SG 11215	223	192
SG 11154	128 - 156	102 - 130
SG 11155	158 - 186	132 - 160
SG 11156	208 - 236	182 - 210

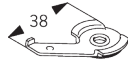

SG 3004
Bride

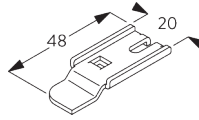

SG 3041
Support



SG 10074
Vis M4x8



SG 10407
Vis M4X10



SG 10492
Vis M4x8



SG 11158
Vis M4x12

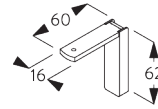

SG 11200
Smart Fix 60 mm

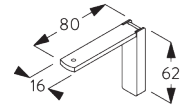

SG 11201
Smart Fix 80 mm

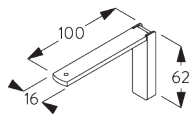

SG 11202
Smart Fix 100 mm

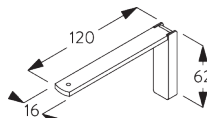

SG 11203
Smart Fix 120 mm

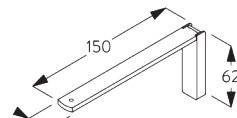

SG 11204
Smart Fix 150 mm

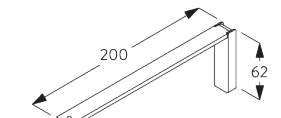

SG 11205
Smart Fix 200 mm

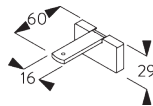

SG 11210
Square Smart Fix 60 mm

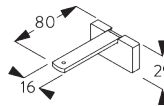

SG 11211
Square Smart Fix 80 mm

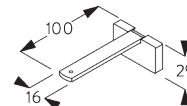

SG 11212
Square Smart Fix 100 mm

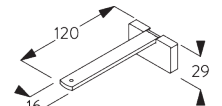

SG 11213
Square Smart Fix 120 mm

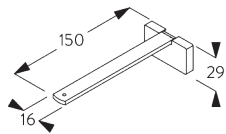

SG 11214
Square Smart Fix 150 mm

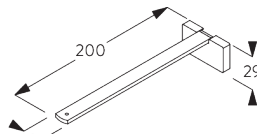

SG 11215
Square Smart Fix 200 mm

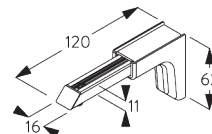

SG 11154
Universal Smart Fix 120 mm

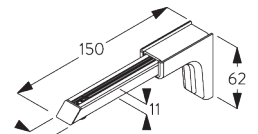

SG 11155
Universal Smart Fix 150 mm

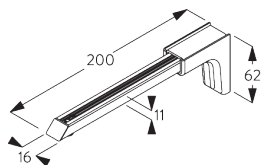

SG 11156
Universal Smart Fix 200 mm

D. FIXATION
ENCASTREE

Profil d'encastrement
SG 10862

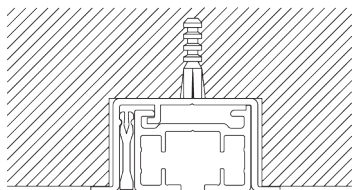

Une cale de blocage par point de fixation.
Pour les détails d'une installation encastrée, se référer au site Silent Gliss.

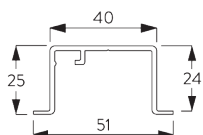

SG 10862
Profil d'encastrement

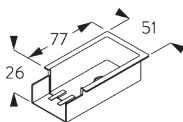

SG 10864
Masque profil d'encastrement

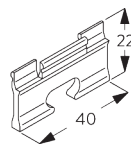

SG 5118
Pièce de blocage

E. FIXATION
SUSPENDU

Suspension SG 6105

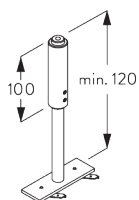
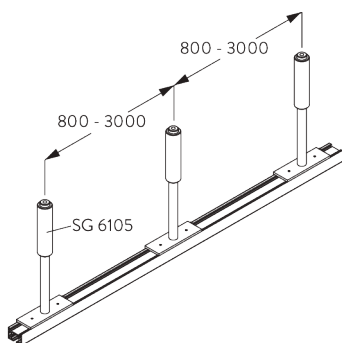

SG 6105
Suspension

Suspension V
SG 6107

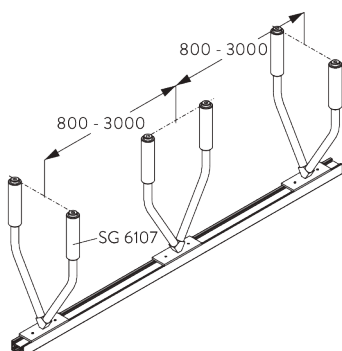

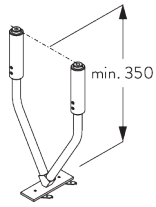

SG 6107

Suspension V complet équipé

OPTIONS SYSTÈME

A. WAVE

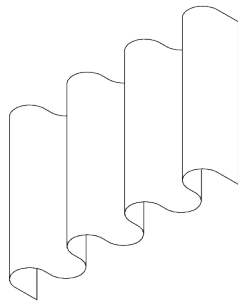

SG 11295

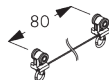

SG 10852

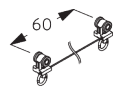

SG 10869

Composants Standards:

- SG 11295 Vis d'arrêt
- SG 10852 Roulers Wave bi-composants 80 mm

Composants en option:

- SG 10869 Roulers Wave bi-composants 60 mm



SG 3582

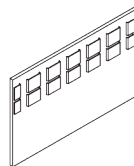

SG 6349

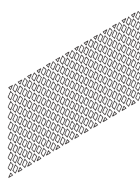

SG 6363

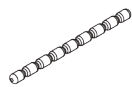

SG 10075



SG 10076

Composants de rideaux:

- SG 3582 Crochet
- SG 6349 Ruban Wave transparent
- SG 6363 Ruban à repasser
- SG 10075 Fil à plomb 50 gr/m
- SG 10076 Barre de lestage

Paquet rideau Wave - Rouler Bi-composants (standard)

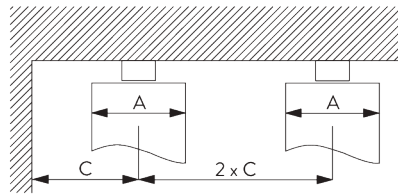
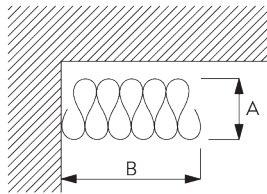



A = Epaisseur du Wave
 B = Largeur paquet rideau
 C = Ecartement minimum

Rouler Bi-composants SG 10852	Nombre de poches entre crochets	Ampleur rideau Approximative	Epaisseur du Wave A	Largeur paquet rideau B	Ecartement minimum C
80	6	~2.1	140	210 mm par ml de tringle	90
80	7	~2.3	160	210 mm par ml de tringle	100







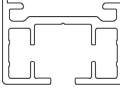
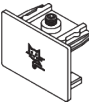
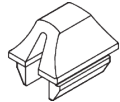

Rouler Bi-composants SG 10869	Nombre de poches entre crochets	Ampleur rideau Approximative	Epaisseur du Wave A	Largeur paquet rideau B	Ecartement minimum C
60	4	~2.1	100	260 mm par ml de tringle	70
60	5	~2.3	120	260 mm par ml de tringle	80

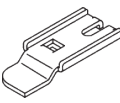
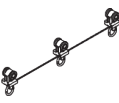
ACCESSOIRES

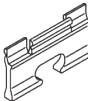
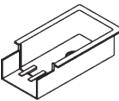
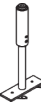
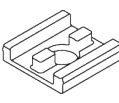
A. ACCESSOIRES STANDARDS

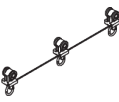
	SG 3004 Bride
	SG 10840 Rouleur bi-composant
	SG 10850 Profil
	SG 11235 Embout
	SG 11465 Ressort d'arrêt delrin

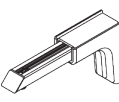
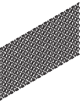
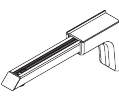
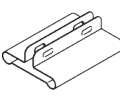
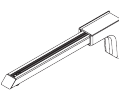
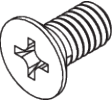
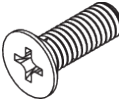
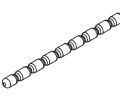
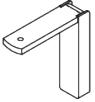
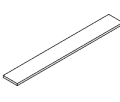
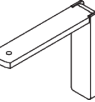
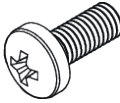
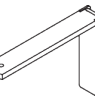
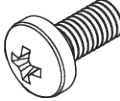
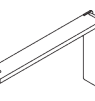
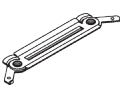
B. ACCESSOIRES EN OPTION

	SG 3041 Support		SG 10852 Rouleur Wave Bi-composants 80 mm
	SG 3582 Agrafe Delrin		SG 10862 Profil d'encastrement
	SG 5118 Pièce de blocage		SG 10864 Masque profil d'encastrement
	SG 6105 Suspension		SG 10865 Clip pour montage
	SG 6107 Suspension V complet équipé		SG 10869 Rouleur Wave Bi-composants 60 mm
	SG 6349 Ruban Wave transparent		SG 11154 Universal Smart Fix 120 mm
	SG 6363 Ruban à repasser		SG 11155 Universal Smart Fix 150 mm
	SG 7002 Protecteur de profil		SG 11156 Universal Smart Fix 200 mm
	SG 10074 Vis M4x8		SG 11158 Vis M4x12
	SG 10075 Fil à plomb 50 gr/m		SG 11200 Smart Fix 60 mm
	SG 10076 Barre de lestage		SG 11201 Smart Fix 80 mm
	SG 10407 Vis M4X10		SG 11202 Smart Fix 100 mm
	SG 10492 Vis M4x8		SG 11203 Smart Fix 120 mm
	SG 10831 Pièce de raccordement		SG 11204 Smart Fix 150 mm



SG 11205

Smart Fix 200 mm

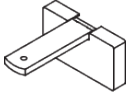

SG 11210

Square Smart Fix 60 mm

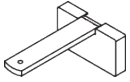

SG 11211

Square Smart Fix 80 mm

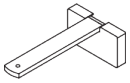

SG 11212

Square Smart Fix 100 mm

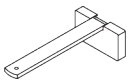

SG 11213

Square Smart Fix 120 mm

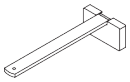

SG 11214

Square Smart Fix 150 mm

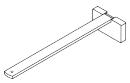

SG 11215

Square Smart Fix 200 mm

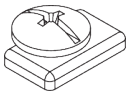

SG 11295

Arrêt

