

SG 4960

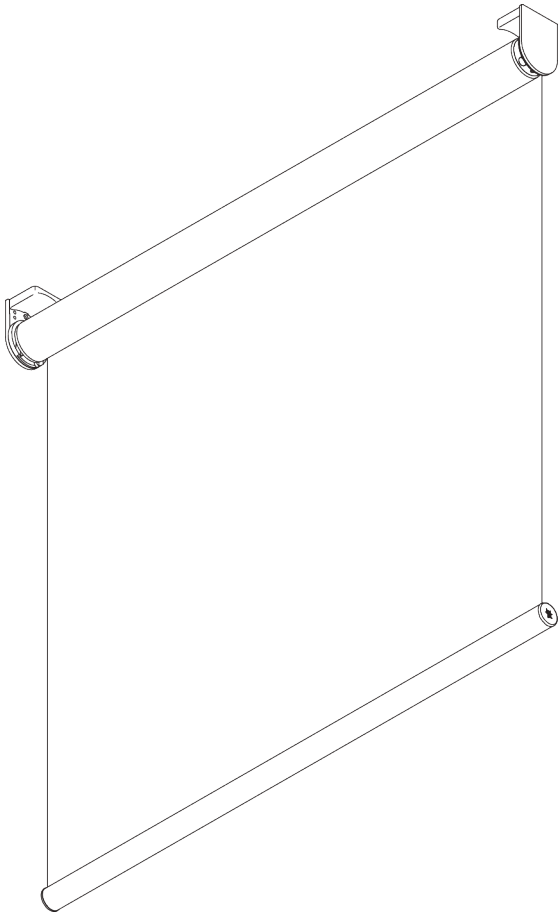

INFORMATION PRODUIT

- **Mode de commande:** Motorisé
- **Gamme:** S - M
- **Installation:** Plafond, Murale, Encastré
- **Couleurs:** Blanc RAL 9016, Gris RAL 7035, Noir RAL 9005; couleurs spéciales possibles
- **Tissus:** Se référer à la collection tissu Silent Gliss

Caractéristiques:

- Moteur silencieux et rapide, fin de courses lente
- Plusieurs options de commandes
- Système double connecté possible
- Support click
- Fascia, boîtier, profil de montage

08/2024/V1

SPÉCIFICATION SYSTÈME

A. DIMENSIONS SYSTÈME



Système individuel: 2.4 m
Système double: 4.8 m



61 cm*
*se référer au tableau des
moteurs



4 m

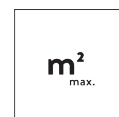

Système individuel:
9.6 m²
Système double: 19.2 m²



5.5 kg

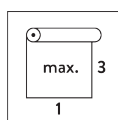

Rapport largeur / hauteur
recommandé
max. 1:3

Hauteur max. du système

Fixation murale (hauteur côté fenêtre)

Épaisseur tissu	mm	0.15	0.20	0.25	0.30	0.35	0.40	0.45	0.50	0.55	0.60	0.65	0.70	0.75	0.80
Hauteur maxi du système	cm	400	400	400	400	400	400	390	350	320	290	270	250	230	220

Fixation plafond (hauteur côté pièce)

Épaisseur tissu	mm	0.15	0.20	0.25	0.30	0.35	0.40	0.45	0.50	0.55	0.60	0.65	0.70	0.75	0.80
Hauteur maxi du système	cm	400	400	400	400	400	400	400	400	400	380	350	330	300	280

B. PROFIL

Information profil

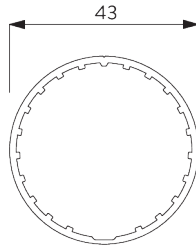

SG 10532
Profil tube ø 42 mm



SG 10760
Barre de lestage

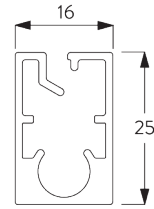

SG 10770
Barre de lestage

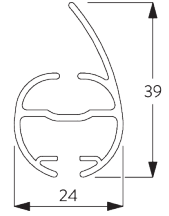

SG 4903
Barre de lestage

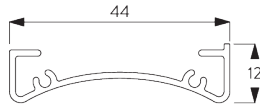

SG 10534
Profil de montage

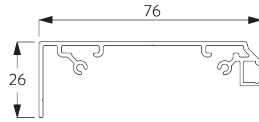

SG 11430
Profil de montage 73 mm

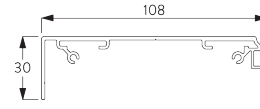

SG 11530
Profil de montage 110 mm

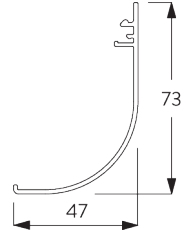

SG 11431
Fascia rond 73 mm

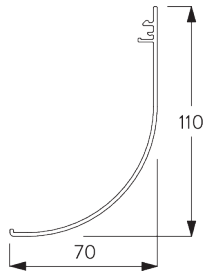

SG 11531
Fascia rond 110 mm

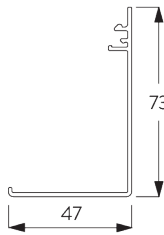

SG 11432
Fascia carré 73 mm

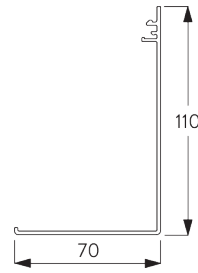

SG 11532
Fascia carré 110 mm

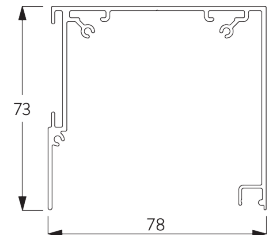

SG 11433
Boîtier 73 mm

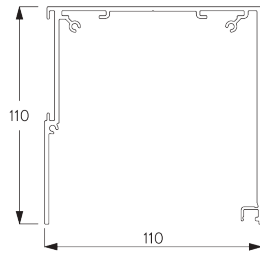

SG 11533
Boîtier 110 mm

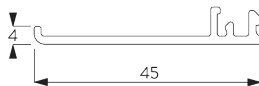

SG 11434
Boîtier cache 73 mm

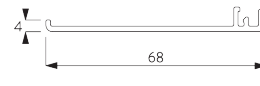

SG 11534
Boîtier cache 110 mm

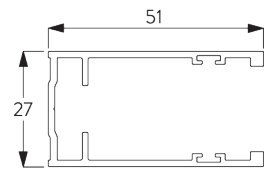

SG 11542
Profil de guidage

C. PRISE DE MESURE

y compris cache support

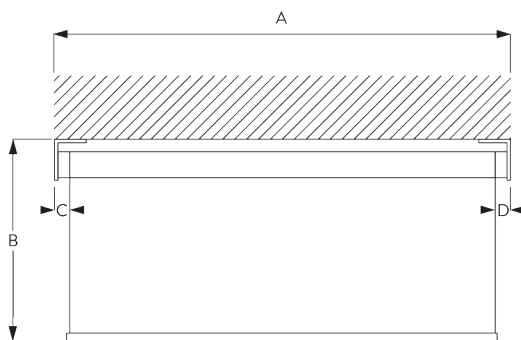

A: Largeur du système
B: Hauteur du système
C: Passage de lumière: 13 mm
D: Passage de lumière côté moteur : 19 mm

Note:
Passage de lumière variable, voir spécifications moteurs.
Toutes les dimensions comprennent 2 mm pour les caches supports par côté!



Fascia / Boîtier

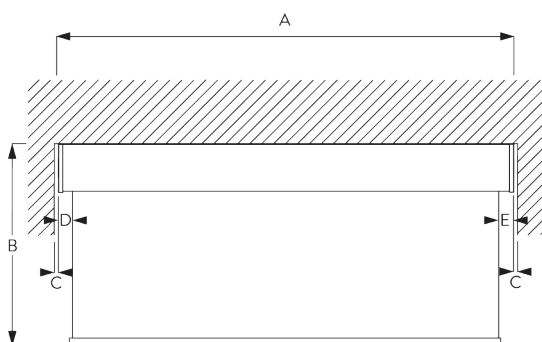

A: Largeur du système
B: Hauteur du système
C: Écart: min. 10 mm (lorsque le cache support est utilisé)*
D: Passage de lumière: 15 mm
E: Passage de lumière côté moteur : 21 mm

Note:
Passage de lumière variable, voir spécifications moteurs.
*Possibilité de rendre le fascia plus large que le système pour réduire l'écart entre le mur et le système.



Fascia / boîtier avec profilés de guidage SG 11542

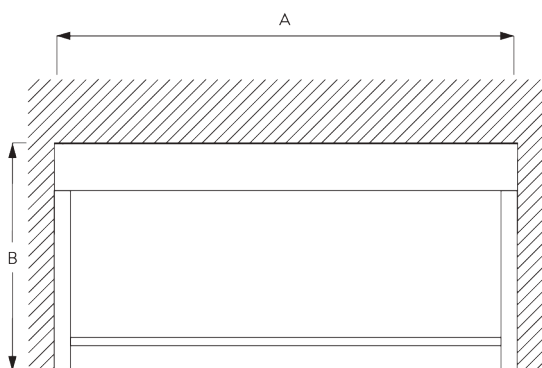

A: Largeur du système
B: Hauteur du système

INSTALLATION

A. INSTRUCTION DE POSE

Pour des informations détaillées, se référer au site web SilentGliss.

Points de fixation



Supports (mural / plafond)

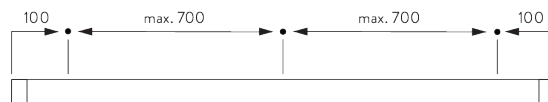

Fascia / boîtier & profil de montage SG 10534 (mural / plafond)

B. FIXATION PLAFOND

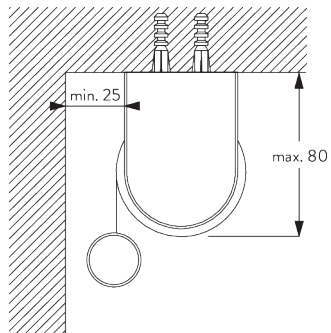

Supports

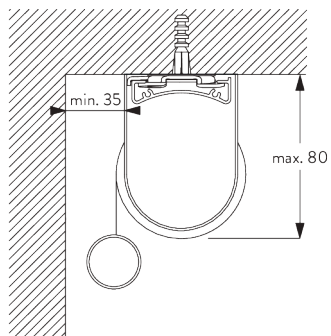

Profil de montage SG 10534 et bride SG 3033 ou SG 3044

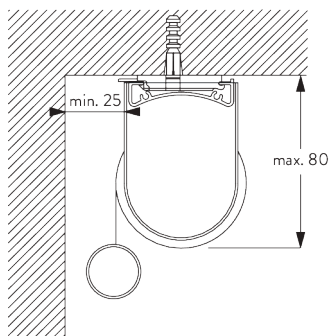

Profil de montage SG 10534 et support click SG 10539
Ne convient pas au système double.

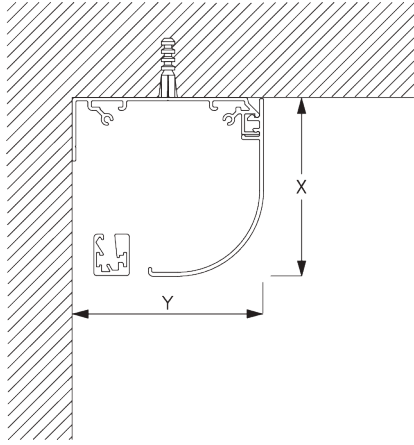

Fascia rond

X = Fascia S 73 mm / Fascia L 110 mm

Y = Fascia S 78 mm / Fascia L 110 mm

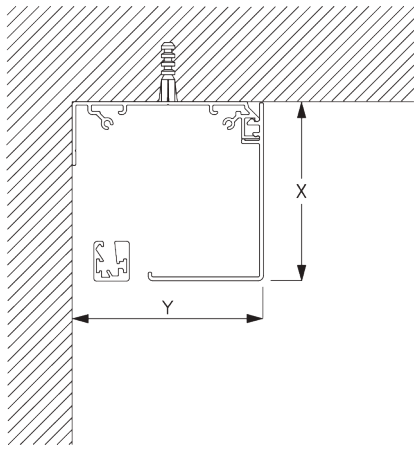

Fascia carré

X = Fascia S 73 mm / Fascia L 110 mm

Y = Fascia S 78 mm / Fascia L 110 mm

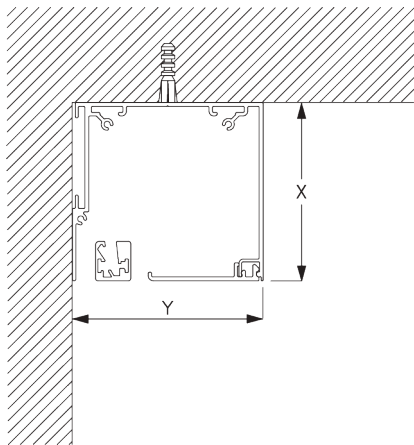

Boîtier

X = Boîtier S 73 mm / Boîtier L 110 mm

Y = Boîtier S 78 mm / Boîtier L 110 mm

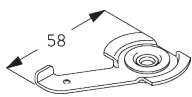

SG 3033
Bride

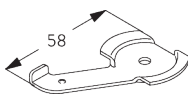

SG 3044
Bride

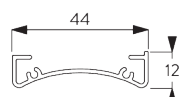

SG 10534
Profil de montage

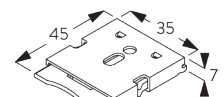

SG 10539
Support click

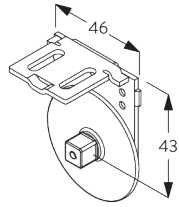

SG 10542
Support côté commande

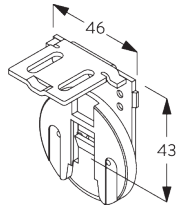

SG 10543
Support



SG 10574
Cache support

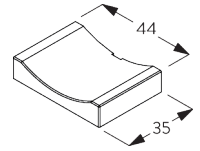

SG 10575
Cache pour vis

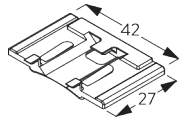

SG 10690
Cale

**C. FIXATION
MURALE**

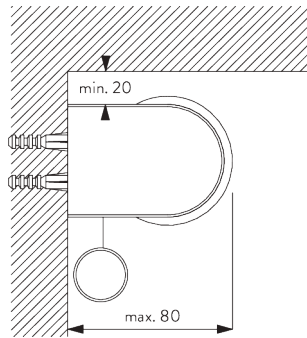

Supports

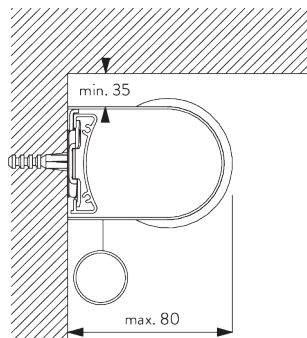

Profil de montage SG 10534 et bride SG 3033 ou SG 3044

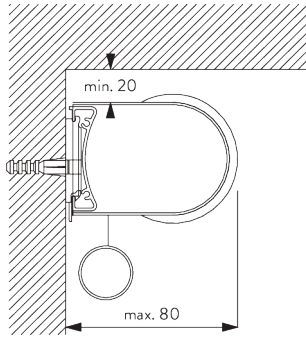

Profil de montage SG 10534 et support click SG 10539
 Ne convient pas au système double.

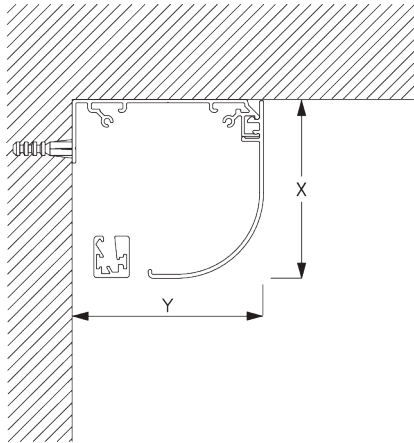

Fascia rond
 X = Fascia S 73 mm / Fascia L 110 mm
 Y = Fascia S 78 mm / Fascia L 110 mm

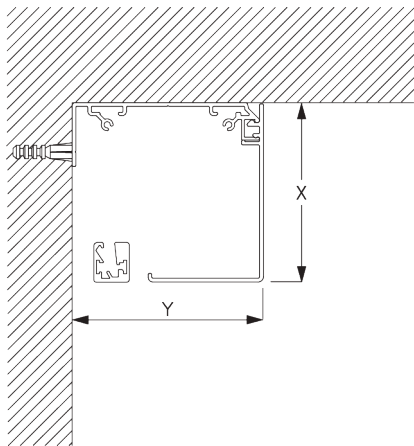

Fascia carré
 X = Fascia S 73 mm / Fascia L 110 mm
 Y = Fascia S 78 mm / Fascia L 110 mm

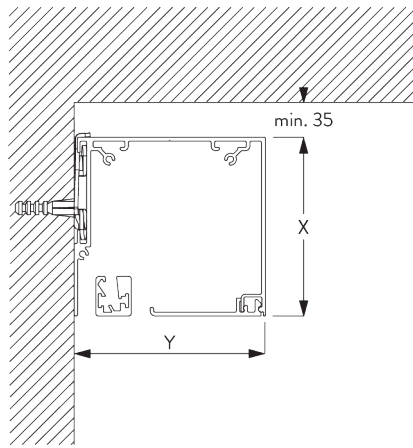

Boîtier S avec bride SG 3044 / Boîtier L avec bride SG 11180

X = Boîtier S 73 mm / Boîtier L 110 mm

Y = Boîtier S 78 mm / Boîtier L 110 mm

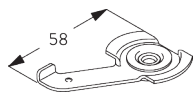

SG 3033

Bride

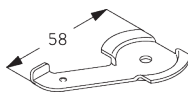

SG 3044

Bride

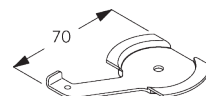

SG 11180

Bride

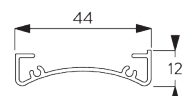

SG 10534

Profil de montage

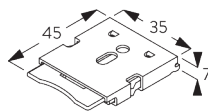

SG 10539

Support click

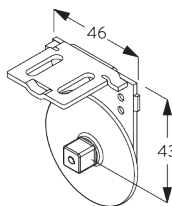

SG 10542

Support côté commande

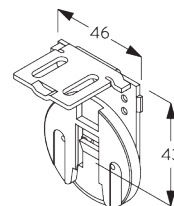

SG 10543

Support

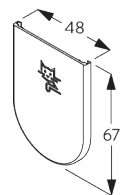

SG 10574

Cache support

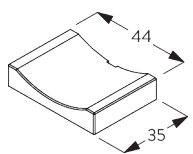

SG 10575

Cache pour vis

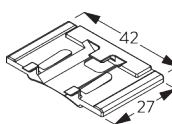

SG 10690

Cale

D. FIXATION
ENCASTRÉE

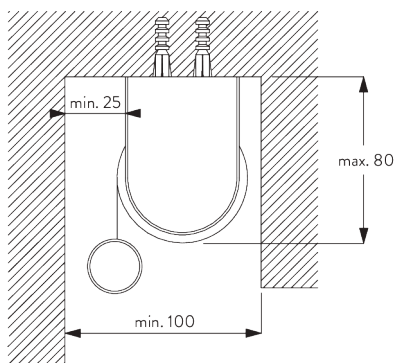

Supports

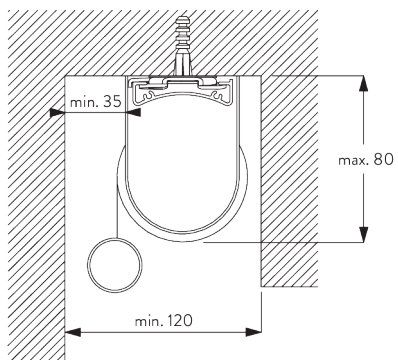

Profil de montage SG 10534 et bride SG 3033 ou SG 3044

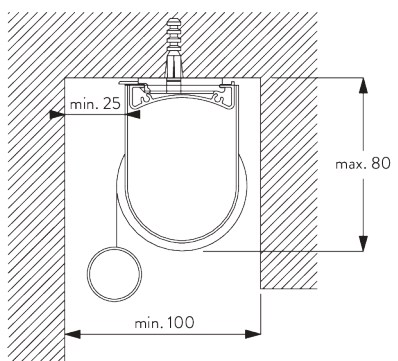

Profil de montage SG 10534 et support click SG 10539
Ne convient pas au système double.

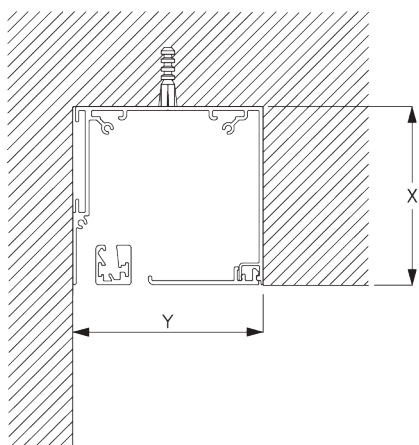

Boîtier

X = Boîtier S 73 mm / Boîtier L 110 mm

Y = Boîtier S min. 79 mm / Boîtier L min. 111 mm

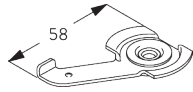

SG 3033
Bride

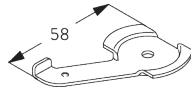

SG 3044
Bride

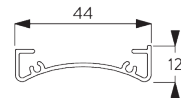

SG 10534
Profil de montage

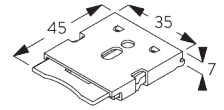

SG 10539
Support click

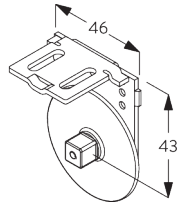

SG 10542
Support côté commande

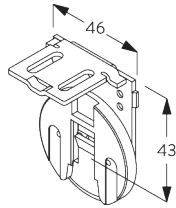

SG 10543
Support



SG 10574
Cache support

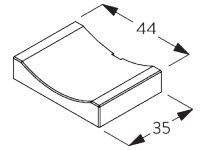

SG 10575
Cache pour vis

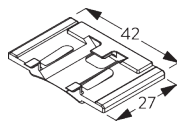

SG 10690
Cale

**E. FIXATION AVEC
OPTION DE
GUIDAGE**

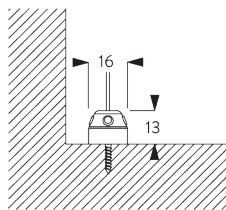

Systeme simple

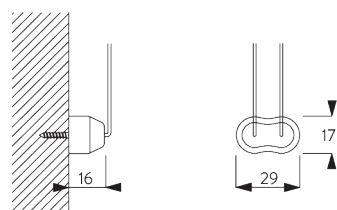
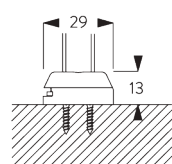
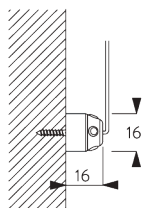

Systeme double (installation juxtaposée)

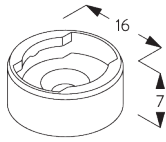

SG 8235
Base basse

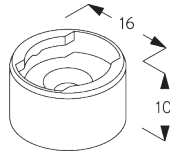

SG 8236
Base basse longue

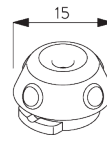

SG 8237
Serre câble

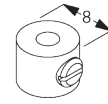

SG 8249
Serre câble

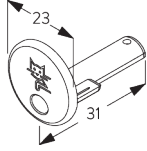

SG 10762
Embout pour barre de lestage
(guidage)

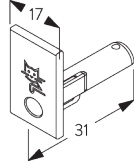

SG 10772
Embout pour barre de lestage
(guidage)

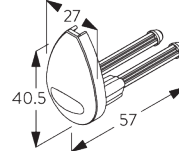

SG 4944
Embout pour barre de lestage
(guidage)

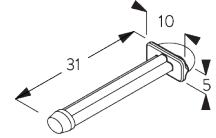

SG 10641
Oeillet de guidage pour
embout barre de lestage

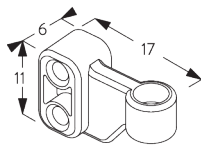

SG 10642
Support de guidage câble

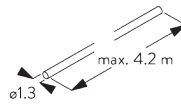

SG 10643
Câble ø 1.3 mm x 4.2 m
(guidage)

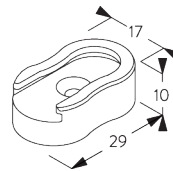

SG 10669
Base longue pour guidage
double système

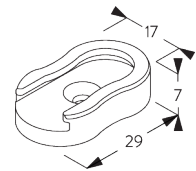

SG 10673
Base courte pour guidage
double système

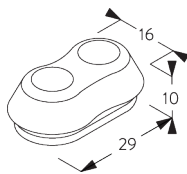

SG 10701
Support pour guidage double
système

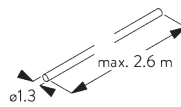

SG 10706
Câble ø 1.3 mm x 2.6 m
(guidage)

OPTIONS SYSTÈME

A. DÉROULEMENT DE LA TOILE

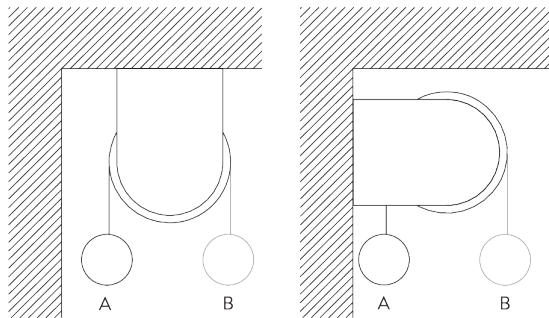

A: Déroulement au plus près de la fenêtre (standard)
B: Déroulement vers l'intérieur de la pièce (option)

B. PROFIL DE MONTAGE

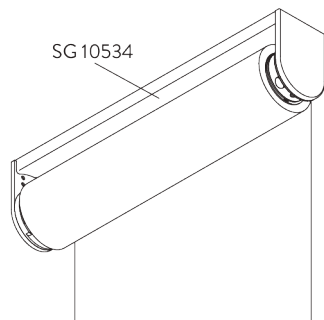

C. GUIDAGE

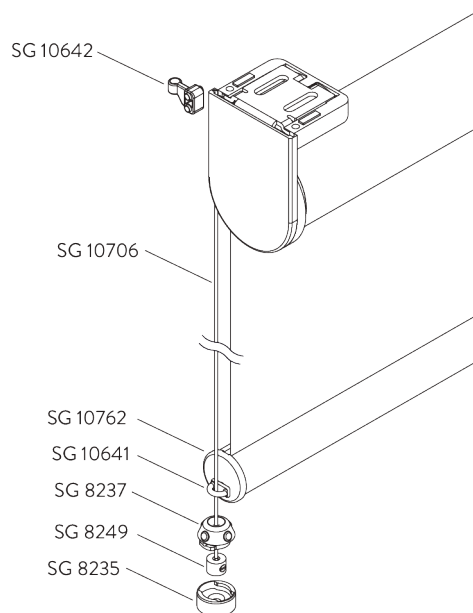

Accessoires complémentaires :

- 2x SG 8235 Base de fixation du câble
- 2x SG 8237 Serre câble
- 2x SG 8249 Serre câble
- 2x SG 10762 Embout pour barre de lestage ronde (guidage)
- 2x SG 10641 Oeillet de guidage pour embout barre de lestage
- 2x SG 10642 Support de guidage câble
- 2x SG 10706 Câble de guidage \varnothing 1.3 mm x 2.6 m

Accessoires optionnels:

- 2x SG 8236 Base basse longue de fixation du câble
- 2x SG 10772 Embout rectangle de barre de charge
- 2x SG 10643 Câble \varnothing 1.3 mm x 4.2 m
- 2x SG 10669 Base longue de fixation du câble
- 2x SG 10673 Base courte de fixation du câble
- 2x SG 10701 Support double de fixation du câble

Note:

- Le passage de lumière latéral augmente avec l'option de guidage
- Guidage sur pente maxi de 15°

D. 2 SYSTÈMES CONNECTÉS

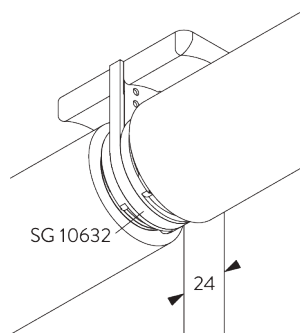

Accessoires complémentaires :

- 1x SG 10558 Adapateur de connection du tube
- 2x SG 10626 Ecrou de connection
- 2x SG 10627 Flasque support
- 1x SG 10628 Adapateur de connection du tube
- 1x SG 10632 Cache support intermédiaire

Note:

- Impossible avec le moteur 24 V SG 10692!

E. DEUX SYSTÈMES CÔTE À CÔTE

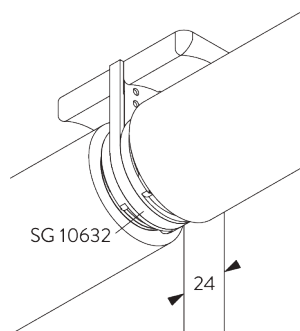

Accessoire complémentaire:

- 1x SG 10632 Cache pour 2 supports ensemble

F. FASCIA / BOÎTIER

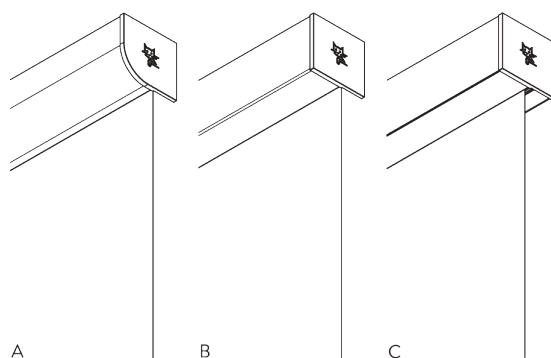

A: Fascia rond

B: Fascia carré

C: Boîtier

Tailles:

- S: 78 x 73 mm
- L: 110 x 110 mm

Note:

- Utilisable uniquement avec la barre de lestage SG 11442
- Impossible avec les systèmes connectés
- Deux systèmes avec un fascia possible sur demande

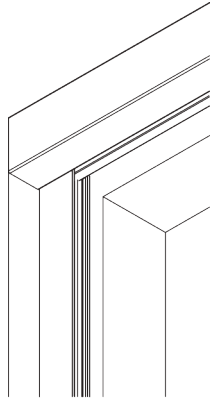

Profil de guidage SG 11542 en option à utiliser avec Fascia ou Boîtier.

Note:

- Uniquement pour installation dans des cadres de fenêtres
- Box: seulement encastré

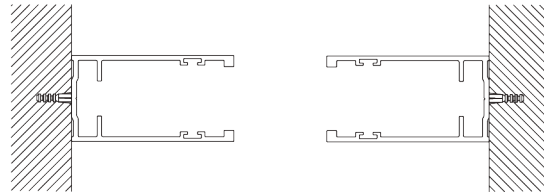

MOTEURS ET CONTRÔLES

A. CARACTÉRISTIQUES MOTEURS

Moteurs	Série 50	Série 20	Série 20	Série 10 K	Série 5	24 V DC
	SG 11250	SG 10321	SG 10320	SG 10514	SG 10715	SG 10692

Caractéristiques moteurs

Fin de course souple	•	•	•			
Fin de course électronique	•	•	•			•
Compteur électronique de révolution moteurs (illimité)	•	•	•			•
Fin de course mécanique				•	•	
Compteur mécanique de révolution moteurs (limité)				•	•	
Deux fins de course intermédiaires possibles		•				
Barre de lestage alignement	•					
Arrêt moteur silencieux		•	•	•		•
Branchement en parallèle possible sans relais		•	•			
Fiche de raccord moteur démontable	•	•	•			
Classe IP	IP 30	IP 44	IP 44	IP 44	IP 44	IP 30

Caractéristiques de contrôle

Contrôle moteur via l'alimentation principale		•	•	•	•	
Contrôle moteur via contacts secs						•
SG Control L (récepteur radio intégré)		•				
Smart by Silent Gliss	•					
Compatible avec les systèmes automates classiques (avec l'interface adéquate)		•	•	•	•	•

B. SPÉCIFICATIONS

MOTEURS

Voir le site Web pour le schéma de câblage.

Moteurs	Passage lumière* C / D = coté manoeuvre	Largeur mini système	Voltage	Ampérage	Fréquence	Vitesse	Fréquence récepteur
Série 50 (Smart by Silent Gliss)							
SG 11250	C: 10 mm / D: 26 mm	61 cm	24 V DC	1.8 A	-	55 rpm	-
Série 20							
SG 10320 (Standard)	C: 13 mm / D: 19 mm	61 cm	230 V AC	0.55 A	50 Hz	70 rpm	-
SG 10321	C: 13 mm / D: 19 mm	61 cm	230 V AC	0.55 A	50 Hz	70 rpm	868/915 MHz
Série 10 K							
SG 10514	C: 10 mm / D: 25 mm	50 cm	230 V AC	0.52 A	50 Hz	30 rpm	-
Série 5							
SG 10715	C: 10 mm / D: 25 mm	61 cm	230 V AC	0.485 A	50-60 Hz	28 rpm	-
24 V DC							
SG 10692	C: 13 mm / D: 19 mm	50 cm	24 V DC	0.7 A	-	25 rpm	-

*Passage lumière Fascia ou boîtier: C +2 mm / D +2 mm

C. MODE DE COMMANDE

Voir le catalogue "Contrôles" pour des détails.

Inverseur mural



Le système peut être commandé par un inverseur mural.

SG Control L

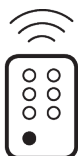

Plusieurs télécommandes manuelles et murales disponibles.



Application Silent Gliss Move.

Smart by Silent Gliss



Système de communication bidirectionnel de conception ouverte qui permet d'intégrer parfaitement les produits à la plupart des principaux systèmes de contrôle domestique.

D. SCHÉMAS DE CÂBLAGE



Se référer au site web Silent Gliss.

ACCESSOIRES

A. ACCESSOIRES STANDARDS

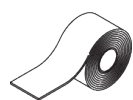

SG 4226

Bande adhésif 30 mm

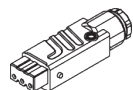

SG 9917

Fiche raccordement male



SG 10284

Anneau



SG 10320

Moteur 230V AC, série 20 S 1.5 / 70

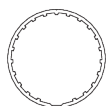

SG 10532

Profil tube ø 42 mm

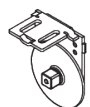

SG 10542

Support côté commande

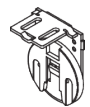

SG 10543

Support

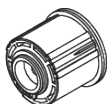

SG 10557

Adaptateur pour profil



SG 10574

Cache support

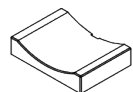

SG 10575

Cache pour vis

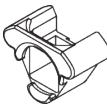

SG 10620

Embout pour moteur série 10 & 20



SG 10621

Adaptateur de tube

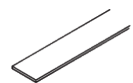

SG 10668

Bande adhésif 10 mm



SG 10760

Barre de lestage



SG 10761

Embout pour barre de lestage

B. ACCESSOIRES EN OPTION



SG 3033

Bride



SG 3044

Bride

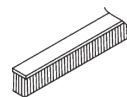

SG 4508

Brosse 5x7



SG 4903

Barre de lestage



SG 8235

Base basse

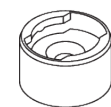

SG 8236

Base basse longue

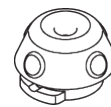

SG 8237

Serre câble

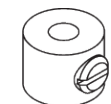

SG 8249

Serre câble

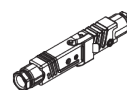

SG 9916

Hirschmann Kit d'accouplement

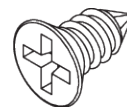

SG 10139

Vis 2.9x6.5

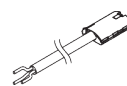

SG 10293

Câble de branchement moteur - 3, 5 et 10 m en option



SG 10300

Télécommande radio 1 canal



SG 10302

Télécommande radio 5 canaux + 1 générale

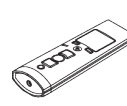

SG 10303

Télécommande radio 10 canaux 2 sous groupes 1 générale

	SG 10321 Moteur 230V AC, série 20 S 1.5 / 70, récepteur radio		SG 10642 Support de guidage câble		SG 10771 Embout pour barre de lestage
	SG 10498 Vis 2.9x9.5		SG 10643 Câble ø 1.3 mm x 4.2 m (guidage)		SG 10772 Embout pour barre de lestage (guidage)
	SG 10514 Moteur 230V AC, série 10 S 3/30 K		SG 10651 Disque intermédiaire avec anneau		SG 10804 Télécommande radio 15 canaux + 5 canaux + 1 Groupé
	SG 10534 Profil de montage		SG 10669 Base longue pour guidage double système		SG 11178 Embout pour barre de lestage
	SG 10539 Support click		SG 10673 Base courte pour guidage double système		SG 11180 Bride
	SG 10544 Support côté commande 24 V DC		SG 10690 Cale		SG 11250 Moteur 24V DC, 50-Series S 1.5/55
	SG 10558 Embout intermédiaire		SG 10692 Moteur 24 V DC, 2/38		SG 11260 Passerelle Cedia
	SG 10622 Adaptateur tube moteur 24V DC		SG 10701 Support pour guidage double système		SG 11261 Passerelle KNX
	SG 10625 Embout moteur		SG 10706 Câble ø 1.3 mm x 2.6 m (guidage)		SG 11262 Module d'extension
	SG 10626 Support métal intermédiaire		SG 10708 Adaptateur pour moteur 24V		SG 11263 Alimentation 24V DC, 2.5A Rail DIN
	SG 10627 Disque intermédiaire		SG 10715 Moteur 230V AC, série 5 S 6/28		SG 11264 Alimentation 24V DC, 3.8A Rail DIN
	SG 10628 Adaptateur support intermédiaire		SG 10753 Plaque moteur		SG 11265 Alimentation 24V DC, 5A Rail DIN
	SG 10632 Cache pour 2 supports		SG 10762 Embout pour barre de lestage (guidage)		SG 11266 Alimentation 24V DC, 10A Rail DIN
	SG 10641 Oeillet de guidage pour embout barre de lestage		SG 10770 Barre de lestage		SG 11322 Vis KA35x10

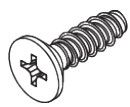

SG 11323
Vis KA35x12

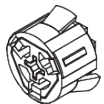

SG 11357
Entraînement par moteur 24 V DC

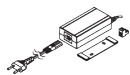

SG 11426
Alimentation 24V / 2A avec câble et prise

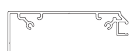

SG 11430
Profil de montage 73 mm



SG 11431
Fascia rond 73 mm

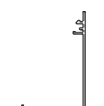

SG 11432
Fascia carré 73 mm

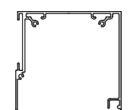

SG 11433
Boîtier 73 mm



SG 11434
Boîtier cache 73 mm



SG 11437
Cache support rond gauche 73 mm



SG 11438
Cache support rond droit 73 mm

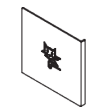

SG 11439
Cache support carré gauche 73 mm

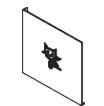

SG 11440
Cache support carré droit 73 mm



SG 11442
Barre de lestage



SG 11443
Embout de barre de charge



SG 11446
Support gauche 73 mm

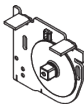

SG 11447
Support droite 73 mm



SG 11448
Support gauche 73 mm



SG 11449
Support droite 73 mm



SG 11450
Support gauche 73 mm



SG 11451
Support droite 73 mm

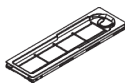

SG 11460
Cache pour Hirschmann prise de courant



SG 11480
Télécommande radio murale 1 canal



SG 11490
Télécommande radio murale 5+1 canaux



SG 11530
Profil de montage 110 mm



SG 11531
Fascia rond 110 mm



SG 11532
Fascia carré 110 mm

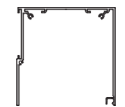

SG 11533
Boîtier 110 mm



SG 11534
Boîtier cache 110 mm



SG 11537
Cache support rond gauche 110 mm



SG 11538
Cache support rond droit 110 mm



SG 11539
Cache support carré gauche 110 mm



SG 11540
Cache support carré droit 110 mm

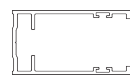

SG 11542
Profil de guidage



SG 11546
Support gauche 110 mm



SG 11547
Support droite 110 mm



SG 11548
Support gauche 110 mm



SG 11549
Support droite 110 mm

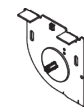

SG 11550
Support gauche 110 mm

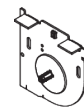

SG 11551
Support droite 110 mm

