

# SG 4960

---

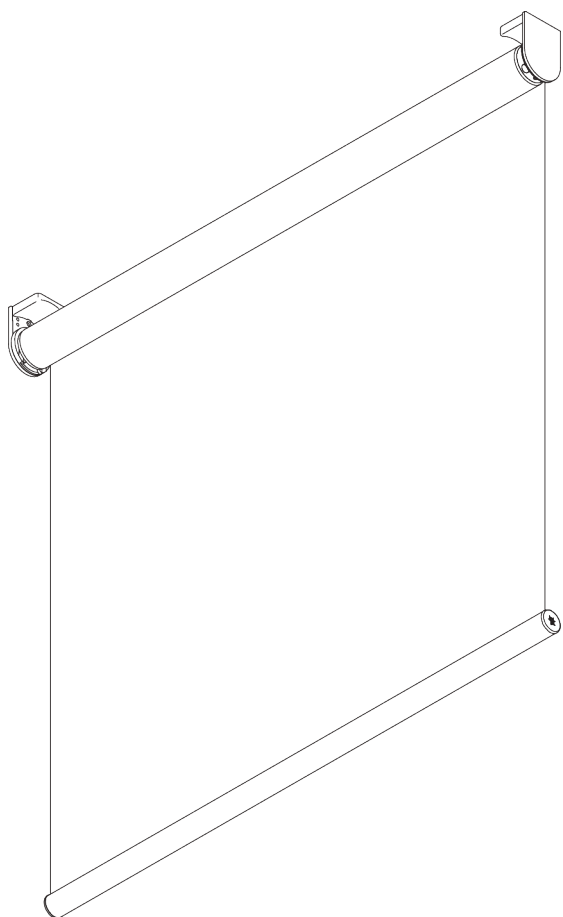
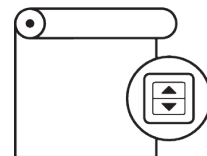

## PRODUCTINFORMATIE

- **Bediening:** elektrisch
- **Groep:** S - M
- **Installatie:** plafond-, wandplaatsing of in-de-dag
- **Kleuren:** wit gelakt RAL 9016, grijs gelakt RAL 7035 of zwart gelakt RAL 9005, andere kleuren op aanvraag
- **Stoffen:** zie Silent Gliss stoffencollectie

### **Kenmerken:**

- Stille, snelle en krachtige motor, soft stop
- Verschillende bedieningsmogelijkheden
- Gekoppelde systemen
- Clicksteunen
- Fascia, Profiel koof, Bevestigingsprofiel

04/2024/V3

# SYSTEEMINFORMATIE

## A. SYSTEEM- AFMETINGEN

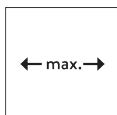

Eén systeem: 2.4 m  
Dubbel systeem: 4.8 m

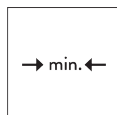

61 cm\*  
\*zie informatie motor

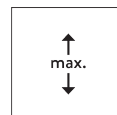

4 m



Eén systeem: 9.6 m<sup>2</sup>  
Dubbel systeem: 19.2 m<sup>2</sup>



5.5 kg

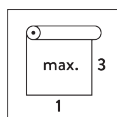

Aanbevolen verhouding  
breedte / hoogte  
max. 1:3

## Max. systeemhoogte

Wandplaatsing (stof raamzijde aflopend):

Stofdikte	mm	0.15	0.20	0.25	0.30	0.35	0.40	0.45	0.50	0.55	0.60	0.65	0.70	0.75	0.80
Max. Systeemhoogte	cm	400	400	400	400	400	400	390	350	320	290	270	250	230	220

Plafond-, wandplaatsing (stof contrarollend aflopend):

Stofdikte	mm	0.15	0.20	0.25	0.30	0.35	0.40	0.45	0.50	0.55	0.60	0.65	0.70	0.75	0.80
Max. Systeemhoogte	cm	400	400	400	400	400	400	400	400	400	380	350	330	300	280

## B. PROFIEL

### Profielinformatie

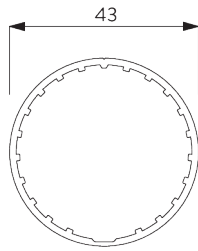

**SG 10532**  
Profiel  $\varnothing$  43 mm



**SG 10760**  
Verzwaringsstaaf

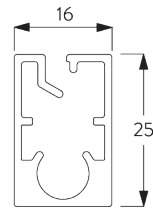

**SG 10770**  
Verzwaringsstaaf

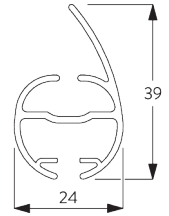

**SG 4903**  
Verzwaringsstaaf

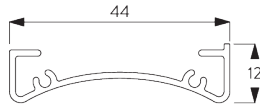

**SG 10534**  
Bevestigingsprofiel

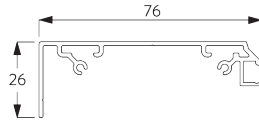

**SG 11430**  
Bevestigingsprofiel 73 mm

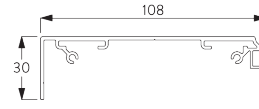

**SG 11530**  
Bevestigingsprofiel 110 mm

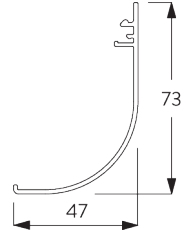

**SG 11431**  
Fascia rond 73 mm

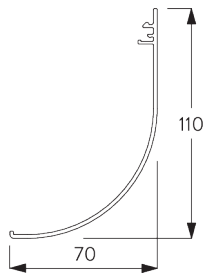

**SG 11531**  
Fascia rond 110 mm

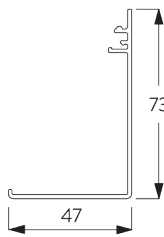

**SG 11432**  
Fascia vierkant 73 mm

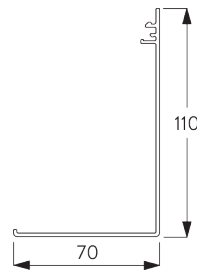

**SG 11532**  
Fascia vierkant 110 mm

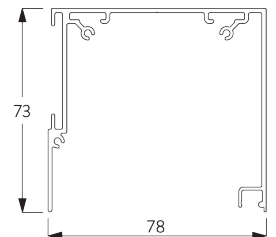

**SG 11433**  
Profiel koof 73 mm

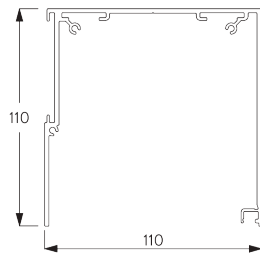

**SG 11533**  
Profiel koof 110 mm

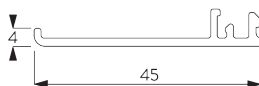

**SG 11434**  
Afdekstuk voor koof 73 mm

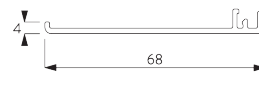

**SG 11534**  
Afdekstuk voor koof 110 mm

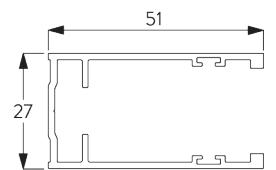

**SG 11542**  
Zijgeleidingsprofiel

## C. HOE E METEN

*incl. afdekkappen*

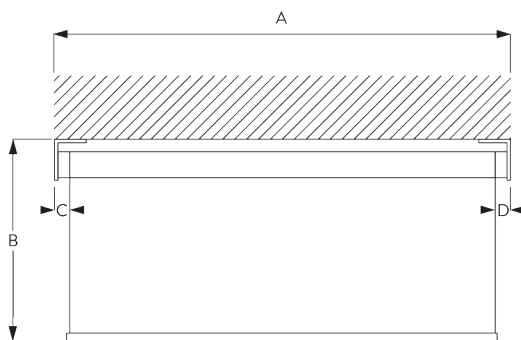

- A: *Systeembreedte*
- B: *Systeemhoogte*
- C: *Lichtopening: 13 mm*
- D: *Lichtopening bedieningszijde: 19 mm*

*Notitie:*  
*Verschillende lichtopeningen zie informatie motor.*  
*Alle afmetingen zijn inclusief 2 mm afdekkappen per zijde!*

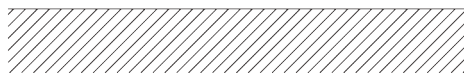

## Fascia / Profiel koof

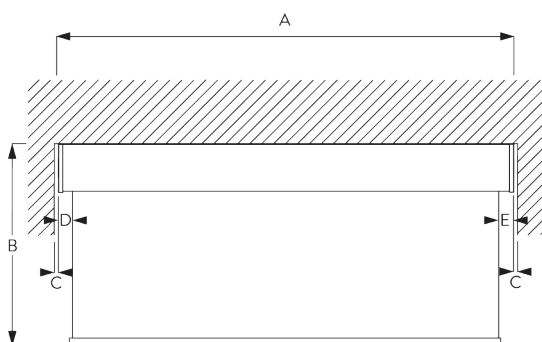

- A: *Systeembreedte*
- B: *Systeemhoogte*
- C: *Tussenruimte: min. 10 mm (bij gebruik van Afdekstuk)\**
- D: *Lichtopening: 15 mm*
- E: *Lichtopening bedieningszijde: 21 mm*

*Notitie:*  
*Verschillende lichtopeningen zie informatie motor.*  
*\*Mogelijk om Fascia breder te maken dan het systeem om de opening tussen muur en systeem te verkleinen.*



## Fascia / profiel koof met zijgeleidingsprofiel SG 11542

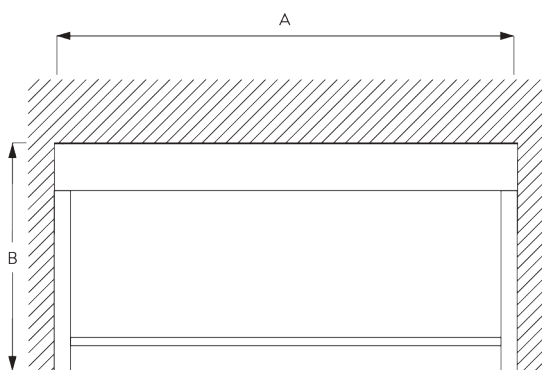

- A: *Systeembreedte*
- B: *Systeemhoogte*

# INSTALLATIE

## A. INSTALLATIE INFORMATIE

*Bezoek onze Silent Gliss website voor gedetailleerde installatie informatie.*

## Bevestigingspunten



Steunen (wand / plafond)

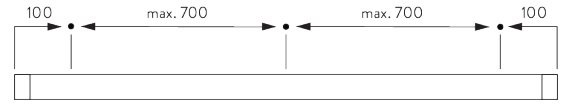

Fascia / Profiel koof & Bevestigingsprofiel SG 10534  
(wand / plafond)

## B. PLAFOND- PLAATSING

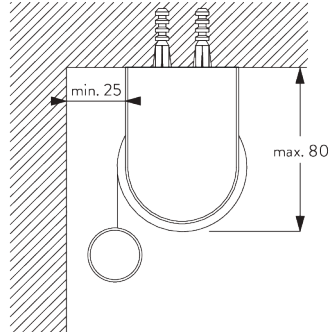

Steunen

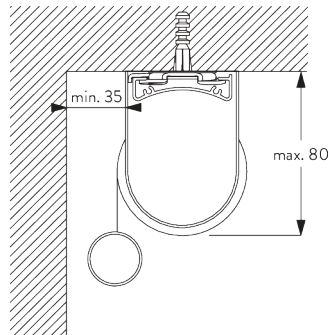

Bevestigingsprofiel SG 10534 en spanner SG 3033 of  
SG 3044

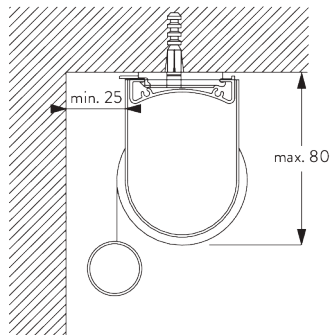

Bevestigingsprofiel SG 10534 en clicksteun SG 10539  
Niet mogelijk met twee gekoppelde systemen!

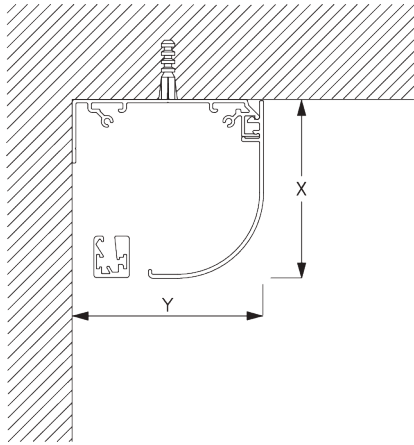

**Fascia rond**

X = Fascia S 73 mm / Fascia L 110 mm

Y = Fascia S 78 mm / Fascia L 110 mm

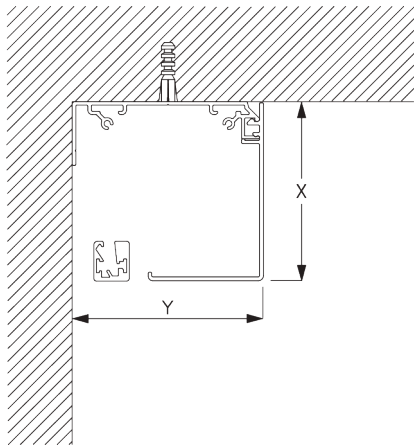

**Fascia vierkant**

X = Fascia S 73 mm / Fascia L 110 mm

Y = Fascia S 78 mm / Fascia L 110 mm

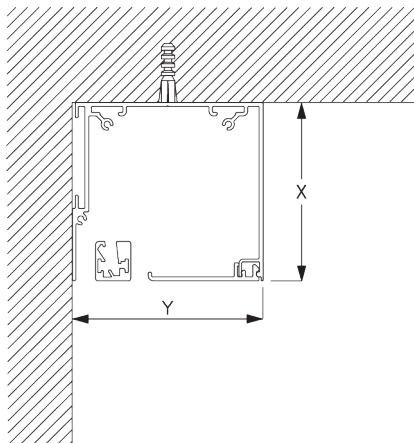

**Profiel koof**

X = Profiel koof S 73 mm / Profiel koof L 110 mm

Y = Profiel koof S 78 mm / Profiel koof L 110 mm

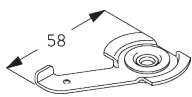

**SG 3033**  
Spanner

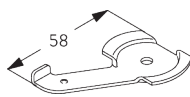

**SG 3044**  
Spanner

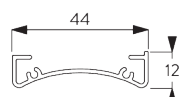

**SG 10534**  
Bevestigingsprofiel

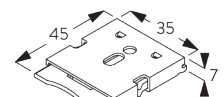

**SG 10539**  
Clicksteun

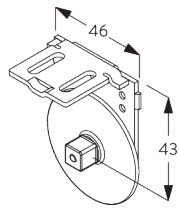

**SG 10542**  
Steun bedieningszijde

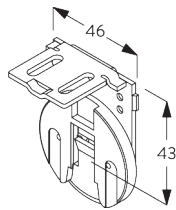

**SG 10543**  
Steun



**SG 10574**  
Afdekstuk voor steun

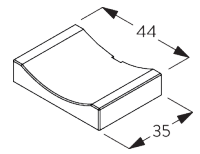

**SG 10575**  
Afdekstuk voor schroef

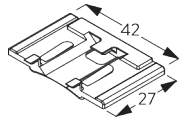

**SG 10690**  
Klem

### C. WAND- PLAATSING

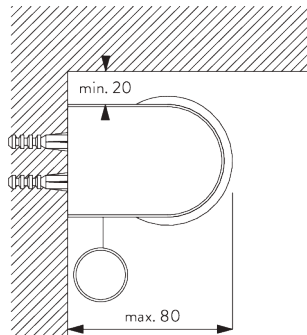

**Steunen**

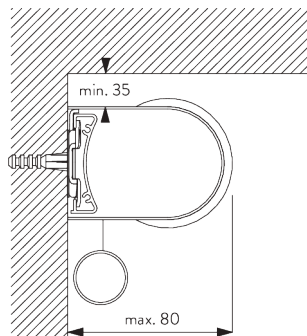

**Bevestigingsprofiel SG 10534 en spanner SG 3033 of SG 3044**

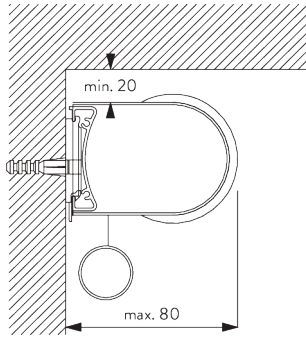

**Bevestigingsprofiel SG 10534 en clicksteun SG 10539**  
 Niet mogelijk met twee gekoppelde systemen!

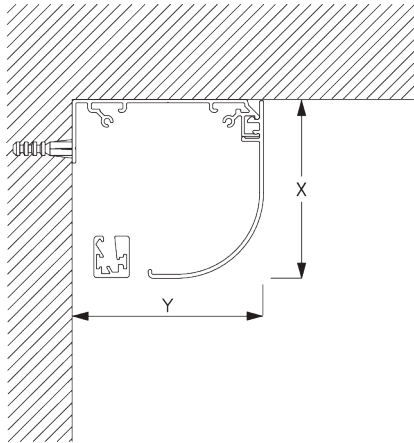

**Fascia rond**  
 X = Fascia S 73 mm / Fascia L 110 mm  
 Y = Fascia S 78 mm / Fascia L 110 mm

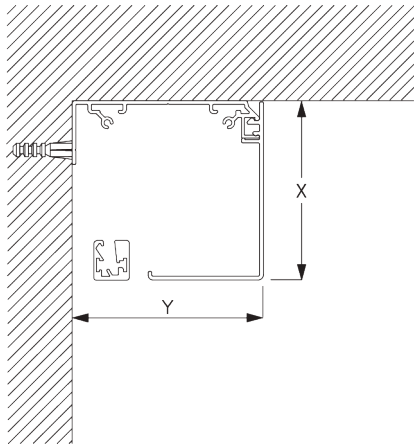

**Fascia vierkant**  
 X = Fascia S 73 mm / Fascia L 110 mm  
 Y = Fascia S 78 mm / Fascia L 110 mm



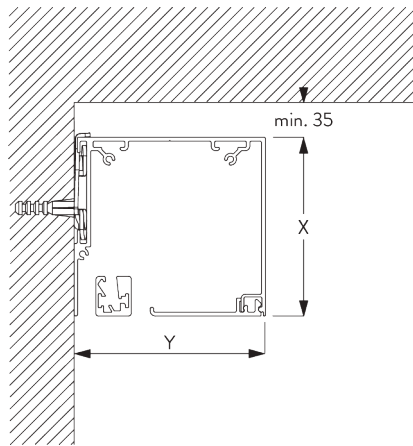

**Profiel koof S met spanner SG 3044 / Profiel koof L met spanner SG 11180**

X = Profiel koof S 73 mm / Profiel koof L 110 mm

Y = Profiel koof S 78 mm / Profiel koof L 110 mm

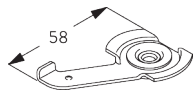

**SG 3033**  
Spanner

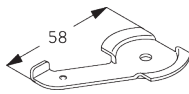

**SG 3044**  
Spanner

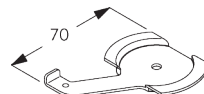

**SG 11180**  
Spanner

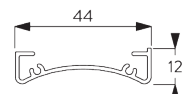

**SG 10534**  
Bevestigingsprofiel

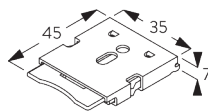

**SG 10539**  
Clicksteun

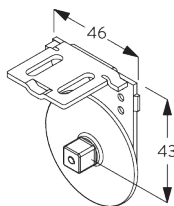

**SG 10542**  
Steun bedieningszijde

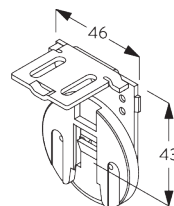

**SG 10543**  
Steun

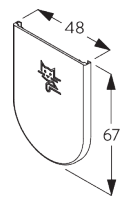

**SG 10574**  
Afdekstuk voor steun

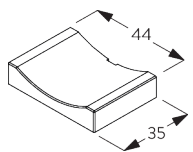

**SG 10575**  
Afdekstuk voor schroef

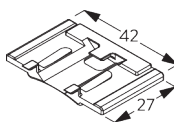

**SG 10690**  
Klem

## D. INGEWERKTE PLAATSING

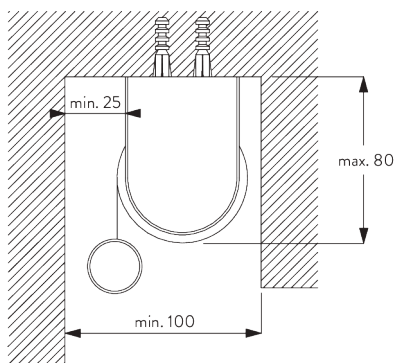

**Steunen**

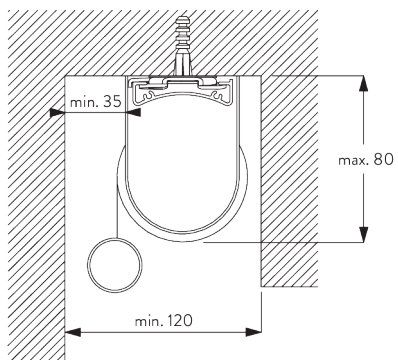

**Bevestigingsprofiel SG 10534 en spanner SG 3033 of  
SG 3044**

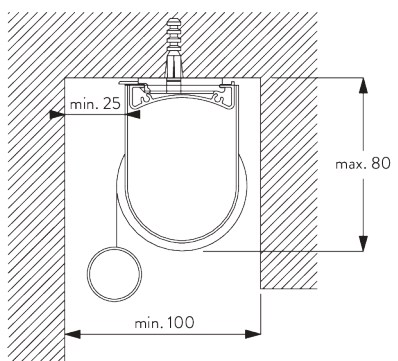

**Bevestigingsprofiel SG 10534 en clicksteen SG 10539**  
*Niet mogelijk met twee gekoppelde systemen!*

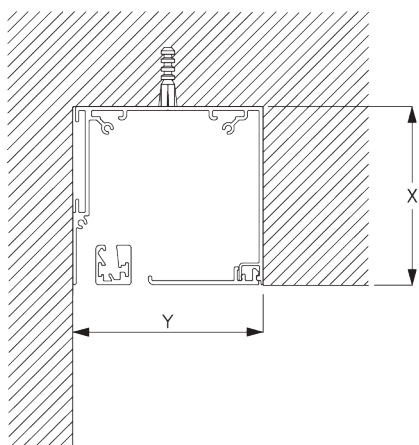

**Profiel koof**

X = Profiel koof S 73 mm / Profiel koof L 110 mm

Y = Profiel koof S min. 79 mm / Profiel koof L min. 111 mm

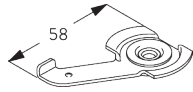

**SG 3033**  
Spanner

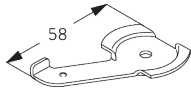

**SG 3044**  
Spanner

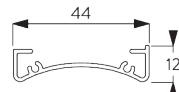

**SG 10534**  
Bevestigingsprofiel

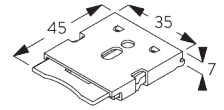

**SG 10539**  
Clicksteun

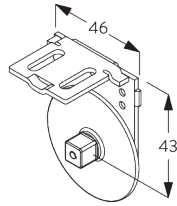

**SG 10542**  
Steun bedieningszijde

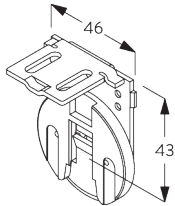

**SG 10543**  
Steun



**SG 10574**  
Afdekstuk voor steun

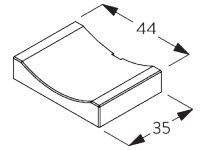

**SG 10575**  
Afdekstuk voor schroef

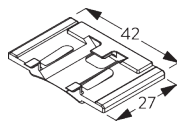

**SG 10690**  
Klem

## E. PLAATSING MET ZIJGELEIDING

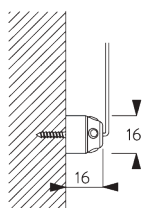
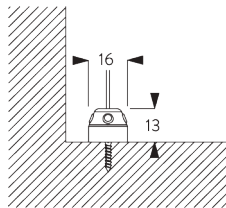

**Enkel systeem**

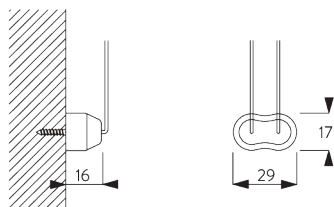
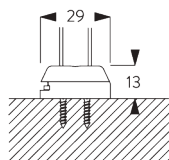

**Dubbel systeem (zij-aan-zij plaatsing)**

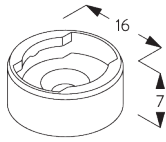

**SG 8235**

Kabelhouder voor zijgeleiding kort

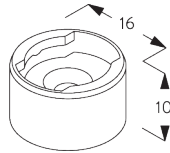

**SG 8236**

Kabelhouder voor zijgeleiding lang

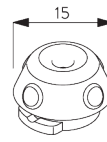

**SG 8237**

Houder zijgeleiding

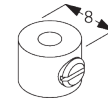

**SG 8249**

Houder voor zijgeleiding

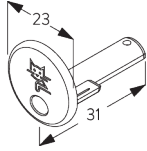

**SG 10762**

Eindstuk voor zijgeleiding

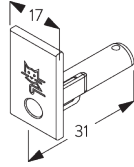

**SG 10772**

Eindstuk voor zijgeleiding

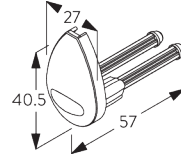

**SG 4944**

Eindstuk voor zijgeleiding

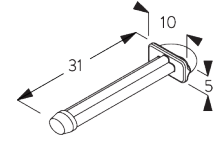

**SG 10641**

Oog voor verzwaringsstaaf met zijgeleiding

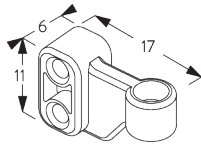

**SG 10642**

Kabelhouder (zijgeleiding)

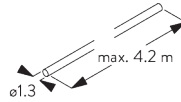

**SG 10643**

Kabel  $\varnothing$  1.3 mm x 4.2 m (zijgeleiding)

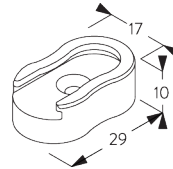

**SG 10669**

Lange kabelhouder voor zijgeleiding dubbel systeem

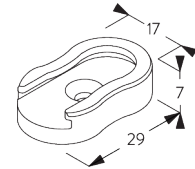

**SG 10673**

Korte kabelhouder voor zijgeleiding dubbel systeem

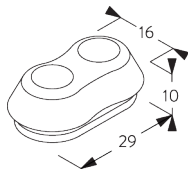

**SG 10701**

Houder voor zijgeleiding dubbel systeem

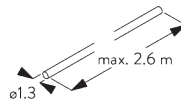

**SG 10706**

Kabel  $\varnothing$  1.3 mm x 2.6 m (zijgeleiding)

# SYSTEEMOPTIES

## A. AFROLLEN VAN DE STOF

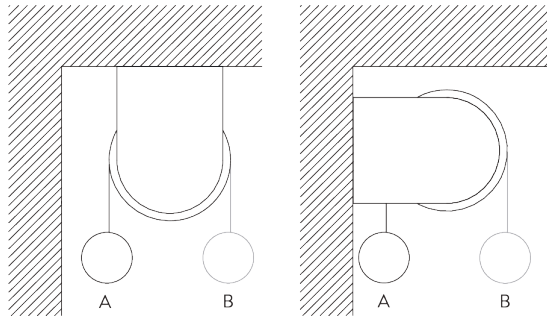

A: Stof raamzijde aflopend (standaard)  
B: Stof contrarollend aflopend (optie)

## B. BEVESTIGINGS-PROFIEL

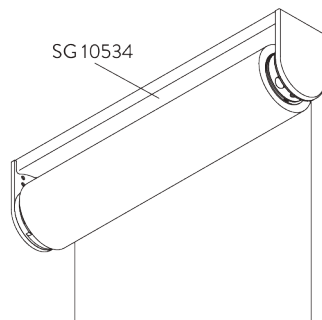

## C. ZIJGELEIDING

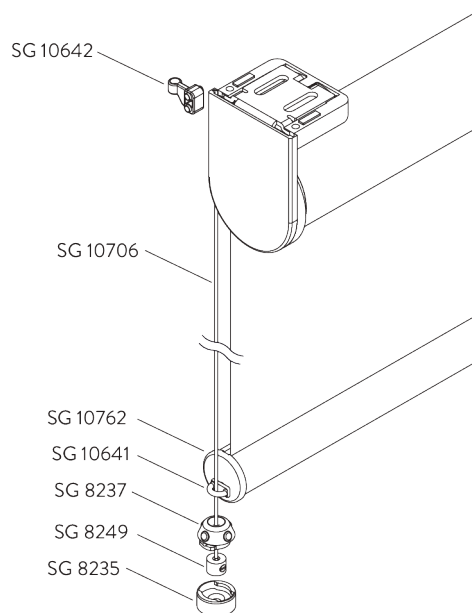

Bijkomende onderdelen:

- 2x SG 8235 Kabelhouder voor zijgeleiding kort
- 2x SG 8237 Houder zijgeleiding
- 2x SG 8249 Houder zijgeleiding
- 2x SG 10762 Eindstuk verzwaringsstaaf rond zijgeleiding
- 2x SG 10641 Oog verzwaringsstaaf zijgeleiding
- 2x SG 10642 Kabelhouder
- 2x SG 10706 Kabel  $\varnothing$  1,3 mm x 2,6 m

Optionele onderdelen:

- 2x SG 8236 Kabelhouder voor zijgeleiding lang
- 2x SG 10772 Eindstuk voor verzwaringsstaaf rechthoek
- 2x SG 10643 Kabel  $\varnothing$  1,3 mm x 4,2 m
- 1x SG 10669 Side guide double base long
- 1x SG 10673 Lange kabelhouder voor zijgeleiding dubbel systeem
- 1x SG 10701 Korte kabelhouder voor zijgeleiding dubbel systeem

Notitie:

- Lichtopening neemt toe bij gebruik van de zijgeleidingsoptie
- Hellingsgraad 15°

## D. 2 GEKOPPELDE SYSTEMEN

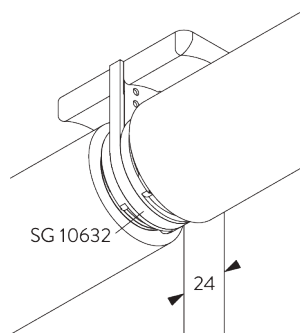

Bijkomende onderdelen:

- 1x SG 10558 Koppelstuk
- 2x SG 10626 Metalen tussensteun
- 2x SG 10627 Koppel flens
- 1x SG 10628 Adapter
- 1x SG 10632 Afdekstuk voor tussensteun

Notitie:

- Niet mogelijk met 24 V-motor SG 10692!

## E. ZIJ-AAN-ZIJ PLAATSING VAN 2 SYSTEMEN

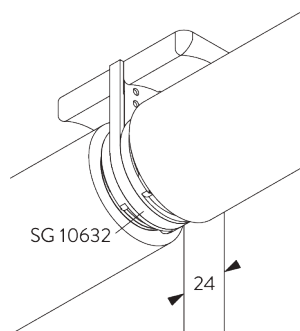

Bijkomende onderdelen:

- 1x SG 10632 Afdeksteun voor beide steunen

## F. FASCIA / PROFIEL KOOF

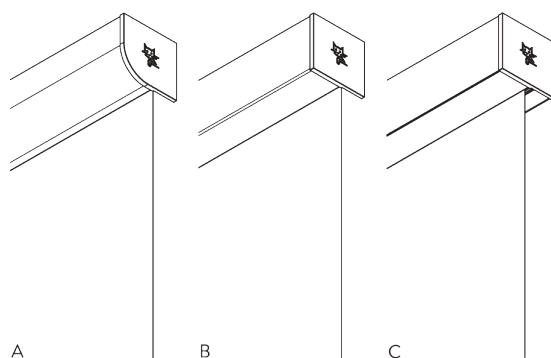

A: Fascia rond

B: Fascia vierkant

C: Profiel koof

Maten

- S: 78 x 73 mm
- L: 110 x 110 mm

Notitie:

- Enkel toepasbaar bij verzwaringsstaaf SG 11442
- Niet mogelijk met gekoppelde systemen
- Twee systemen met één Fascia mogelijk op aanvraag

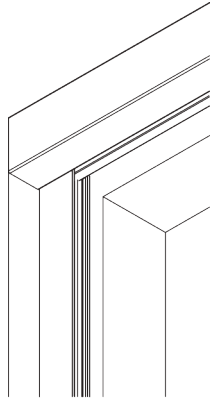

Optionele Zijgeleidingsprofiels SG 11542 te gebruiken met Fascia of Profiel koof.

Notitie:

- Alleen toepasbaar met ingewerkte plaatsing
- Profiel koof: alleen inbouwfitting

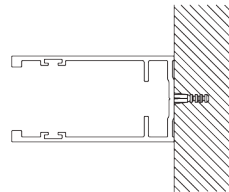
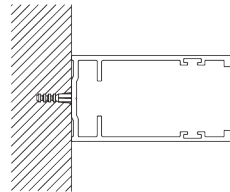

# MOTOREN EN BESTURINGSMOGELIJKHEDEN

## A. KENMERKEN MOTOR

Motoren	50-Series	20-Series	20-Series	10-Series K	5-Series	24 V DC
	SG 11250	SG 10321	SG 10320	SG 10514	SG 10715	SG 10692

Kenmerken	50-Series	20-Series	20-Series	10-Series K	5-Series	24 V DC
Soft stop	•	•	•			
Elektronische eindstop	•	•	•			•
Electronic revolution counter (unlimited revolution)	•	•	•			•
Mechanische eindstop				•	•	
Mechanical revolution counter (limited revolution)				•	•	
Twee tussenposities mogelijk		•				
Uitlijnen van de verzwaringsstaaf	•					
Geruisloze stop		•	•	•		•
Parallelschakeling mogelijk zonder bijkomende relais		•	•			
Plug-in motorkabel	•	•	•			
IP klasse	IP 30	IP 44	IP 44	IP 44	IP 44	IP 30

Aansturingmogelijkheden	50-Series	20-Series	20-Series	10-Series K	5-Series	24 V DC
Netspanningsregeling		•	•	•	•	
Droog contact						•
SG Control L (met ontvanger)		•				
Smart by Silent Gliss	•					
Geschikt voor alle domotica systemen		•	•	•	•	•

## B. INFORMATIE

### MOTOR

Motoren	Lichtopening* C / D = bedieningszijde	Min. systeem breedte	Voltage	Ampère	Frequentie	Snelheid	Frequentie ontvanger
<b>50-Series (Smart by Silent Gliss)</b>							
SG 11250	C: 9 mm / D: 26 mm	61 cm	24 V DC	1.8 A	-	55 rpm	-
<b>20-Series</b>							
SG 10320 (standard)	C: 13 mm / D: 19 mm	61 cm	230 V AC	0.55 A	50 Hz	70 rpm	-
SG 10321	C: 13 mm / D: 19 mm	61 cm	230 V AC	0.55 A	50 Hz	70 rpm	868/915 MHz
<b>10-Series K</b>							
SG 10514	C: 9 mm / D: 25 mm	50 cm	230 V AC	0.52 A	50 Hz	30 rpm	-
<b>5-Series</b>							
SG 10715	C: 9 mm / D: 25 mm	61 cm	230 V AC	0.485 A	50-60 Hz	28 rpm	-
<b>24 V DC</b>							
SG 10692	C: 13 mm / D: 19 mm	50 cm	24 V DC	0.7 A	-	25 rpm	-

\*Lichtopening Fascia of Profiel koof: C +2 mm / D +2 mm

## C. BESTURINGS- MOGELIJKHEDEN

Zie catalogus "controles" voor details.

### Wandschakelaar



Systeem kan worden bediend met vaste wandschakelaar.

### SG Control L

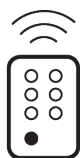

Diverse draadloze hand- en wandzenders beschikbaar.



Silent Gliss Move App.

### Smart by Silent Gliss



Open ontworpen tweewegcommunicatiesysteem waarmee de producten feilloos kunnen worden geïntegreerd met de meeste grote gebouwbeheersystemen.

## D. AANSLUIT- SCHEMA'S



Raadpleeg onze Silent Gliss-website.



# ONDERDELEN

## A. STANDAARD ONDERDELEN

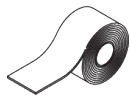

**SG 4226**  
Kleefband 30 mm

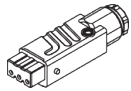

**SG 9917**  
Hirschmann contra stekker



**SG 10284**  
Ring



**SG 10320**  
Motor 230V AC, 20 Series S 1.5/70



**SG 10532**  
Profiel ø 43 mm



**SG 10542**  
Steun bedieningszijde

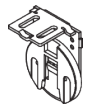

**SG 10543**  
Steun

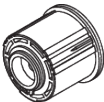

**SG 10557**  
Adapter voor profiel



**SG 10574**  
Afdekstuk voor steun

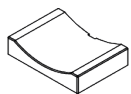

**SG 10575**  
Afdekstuk voor schroef

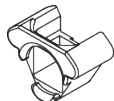

**SG 10620**  
Eindstuk voor motor



**SG 10621**  
Buisadapter



**SG 10668**  
PVC strip en kleefband 10 mm



**SG 10760**  
Verzwaringsstaaf



**SG 10761**  
Eindstuk voor verzwaringsstaaf

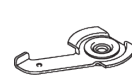

**SG 3033**  
Spanner



**SG 3044**  
Spanner

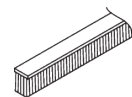

**SG 4508**  
Borstel 5x7



**SG 4903**  
Verzwaringsstaaf

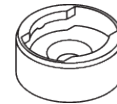

**SG 8235**  
Kabelhouder voor zijgeleiding kort

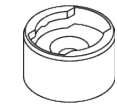

**SG 8236**  
Kabelhouder voor zijgeleiding lang

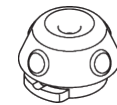

**SG 8237**  
Houder zijgeleiding



**SG 8249**  
Houder voor zijgeleiding

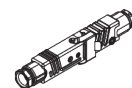

**SG 9916**  
Hirschmann stekkerset

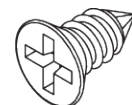

**SG 10139**  
Schroef 2.9x6.5

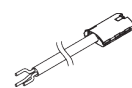

**SG 10293**  
Aansluitkabel 3, 5 en 10 m optioneel

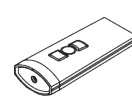







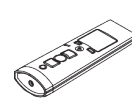



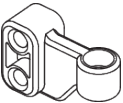

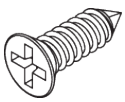
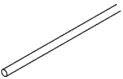
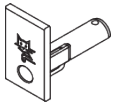
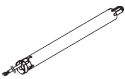





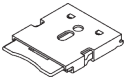



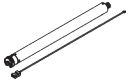
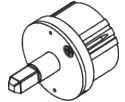

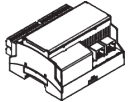

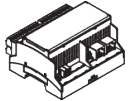
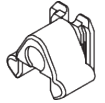
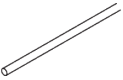
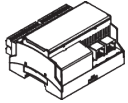
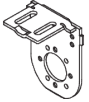
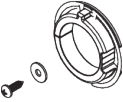
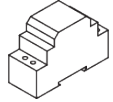
**SG 10300**  
Afstandsbediening, 1 kanaal

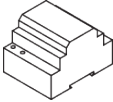

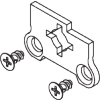
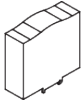
**SG 10302**  
Afstandsbediening, 5+1 kanaal

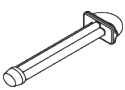
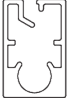

**SG 10303**  
Afstandsbediening, 10+2+1 kanalen

	<b>SG 10321</b> Motor 230V AC, 20 Series S 1.5/70, radio ontvanger		<b>SG 10642</b> Kabelhouder (zijgeleiding)		<b>SG 10771</b> Eindstuk voor verzwaringsstaaf
	<b>SG 10498</b> Schroef 2.9x9.5		<b>SG 10643</b> Kabel ø 1.3 mm x 4.2 m (zijgeleiding)		<b>SG 10772</b> Eindstuk voor zijgeleiding
	<b>SG 10514</b> Motor 230V AC, 10 Series S 3/30 K		<b>SG 10651</b> Koppel flens met ring		<b>SG 10804</b> Afstandsbediening 15 kanalen
	<b>SG 10534</b> Bevestigingsprofiel		<b>SG 10669</b> Lange kabelhouder voor zijgeleiding dubbel systeem		<b>SG 11178</b> Eindstuk voor verzwaringsstaaf dubbel systeem
	<b>SG 10539</b> Clicksteun		<b>SG 10673</b> Korte kabelhouder voor zijgeleiding dubbel systeem		<b>SG 11180</b> Spanner
	<b>SG 10544</b> Steun bedieningszijde 24 V DC		<b>SG 10690</b> Klem		<b>SG 11250</b> Motor 24V DC, 50-Series S 1.5/55
	<b>SG 10558</b> Koppelstuk		<b>SG 10692</b> Motor 24 V DC, 2/38		<b>SG 11260</b> Gateway Cedia
	<b>SG 10622</b> Buis adapter, 24 V DC		<b>SG 10701</b> Houder voor zijgeleiding dubbel systeem		<b>SG 11261</b> Gateway KNX
	<b>SG 10625</b> Eindstuk motor		<b>SG 10706</b> Kabel ø 1.3 mm x 2.6 m (zijgeleiding)		<b>SG 11262</b> Uitbreidseenheid
	<b>SG 10626</b> Metalen tussensteun		<b>SG 10708</b> Adapter voor motor 24 V DC		<b>SG 11263</b> Voeding 24V DC, 2.5 Ampère DIN rail
	<b>SG 10627</b> Koppel flens		<b>SG 10715</b> Motor 230V AC, 5 Series S 6/28		<b>SG 11264</b> Voeding 24V DC, 3.8 Ampère DIN rail
	<b>SG 10628</b> Adapter voor tussensteun		<b>SG 10753</b> Motorplaat		<b>SG 11265</b> Voeding 24V DC, 5 Ampère DIN rail
	<b>SG 10632</b> Afdekstuk voor 2 steunen		<b>SG 10762</b> Eindstuk voor zijgeleiding		<b>SG 11266</b> Voeding 24V DC, 10 Ampère DIN rail
	<b>SG 10641</b> Oog voor verzwaringsstaaf met zijgeleiding		<b>SG 10770</b> Verzwaringsstaaf		<b>SG 11322</b> Schroef KA35x10

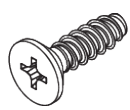

**SG 11323**

Schroef KA35x12

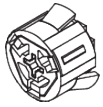

**SG 11357**

Motor adapter Somfy 24 V DC

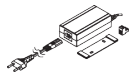

**SG 11426**

Transformator 24V / 2A met kabel en stekker



**SG 11430**

Bevestigingsprofiel 73 mm



**SG 11431**

Fascia rond 73 mm



**SG 11432**

Fascia vierkant 73 mm

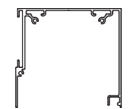

**SG 11433**

Profiel koof 73 mm



**SG 11434**

Afdekstuk voor koof 73 mm



**SG 11437**

Afdekstuk voor steun rond links 73 mm



**SG 11438**

Afdekstuk voor steun rond rechts 73 mm



**SG 11439**

Afdekstuk voor steun vierkant links 73 mm



**SG 11440**

Afdekstuk voor steun vierkant rechts 73 mm



**SG 11442**

Verzwaringsstaaf



**SG 11443**

Eindstuk voor verzwaringsstaaf



**SG 11446**

Steun links 73 mm



**SG 11447**

Steun rechts 73 mm

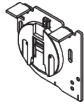

**SG 11448**

Steun links 73 mm

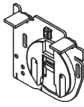

**SG 11449**

Steun rechts 73 mm



**SG 11450**

Steun links 73 mm



**SG 11451**

Steun rechts 73 mm

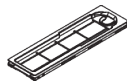

**SG 11460**

Afdekking voor Hirschmann-stekker



**SG 11480**

Wandchakelaar 1 kanaal



**SG 11490**

Wandchakelaar 5+1 kanaal



**SG 11530**

Bevestigingsprofiel 110 mm



**SG 11531**

Fascia rond 110 mm



**SG 11532**

Fascia vierkant 110 mm

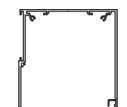

**SG 11533**

Profiel koof 110 mm



**SG 11534**

Afdekstuk voor koof 110 mm



**SG 11537**

Afdekstuk voor steun rond links 110 mm



**SG 11538**

Afdekstuk voor steun rond rechts 110 mm



**SG 11539**

Afdekstuk voor steun vierkant links 110 mm



**SG 11540**

Afdekstuk voor steun vierkant rechts 110 mm

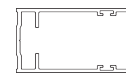

**SG 11542**

Zijgeleidingsprofiel



**SG 11546**

Steun links 110 mm



**SG 11547**

Steun rechts 110 mm



**SG 11548**

Steun links 110 mm



**SG 11549**

Steun rechts 110 mm



**SG 11550**

Steun links 110 mm



**SG 11551**

Steun rechts 110 mm

