

SG 8960

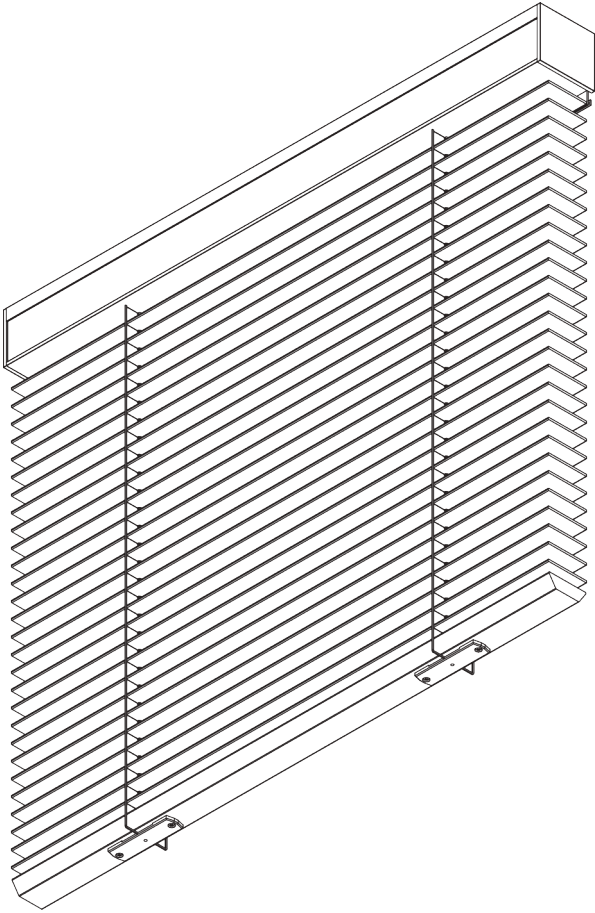
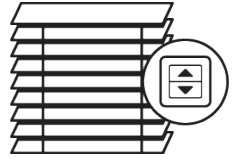

PRODUCTINFORMATIE

- **Bediening:** *elektrisch*
- **Groep:** *L*
- **Installatie:** *plafond- of wandplaatsing*
- **Kleuren:** *zie Silent Gliss lamellencollectie*

Kenmerken:

- *Geoptimaliseerde lichtregeling*
- *Verschillende bedieningsmogelijkheden*
- *Lamellen: hout, aluminium en/of leder*
- *Breedte van de lamellen: 50 mm*
- *Bovenprofiel en lamellen in dezelfde kleur*
- *Keuze uit ladderkoord of decoratieve ladderband*

SYSTEEMINFORMATIE

A. SYSTEEM- AFMETINGEN

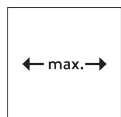

Hout / Leder: 2.4 m
Aluminium: 3.6 m



65 cm

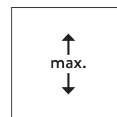



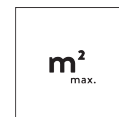



Hout / leder: 2.75 m
Aluminium: 3.6 m

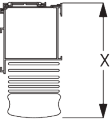

Hout / leder: 4.6 m²
Aluminium: 10 m²

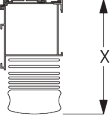
Pakkethoogte

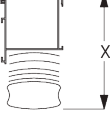
Notitie: de pakkethoogte zal hoger zijn wanneer er voor ladderband gekozen wordt

Hout				↑ max. ↓							
		50 mm	X	60	90	120	150	180	210	240	275
								12	15	17	20
(cm)											
Leder				↑ max. ↓							
		50 mm	X	60	90	120	150	180	210	240	275
								16	18	20	22
(cm)											
Aluminium				↑ max. ↓							
		50 mm	X	100	200	300	360				
								10	13	17	20
(cm)											

B. PROFIEL

Profielinformatie

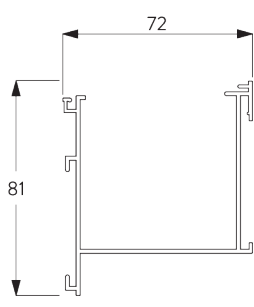

SG 8935
Profiel

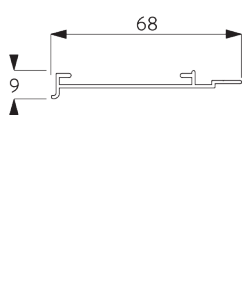

SG 8936
Profiel

C. HOE TE METEN

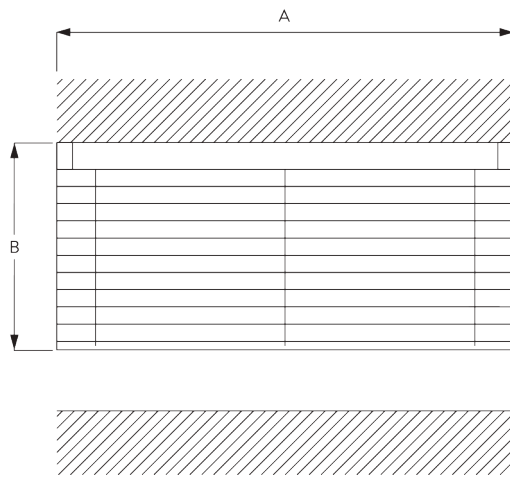

A: Systeembreedte
B: Systemhoogte

INSTALLATIE

A. INSTALLATIE INFORMATIE

Bezoek onze *Silent Gliss* website voor gedetailleerde installatie informatie.

Bevestigingspunten

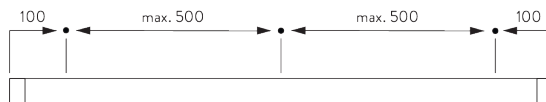

B. PLAFOND- PLAATSING

Spanner SG 3003

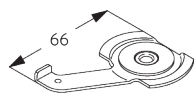
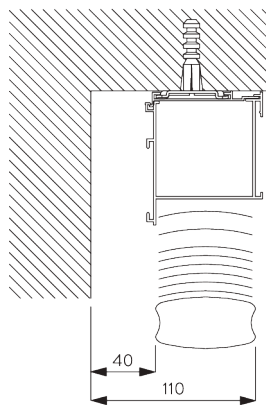

SG 3003
Spanner

**C. WAND-
PLAATSING**

Spanner SG 3003

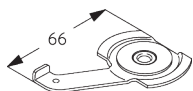
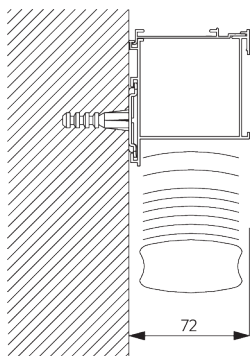

SG 3003

Spanner

**D. PLAATSING MET
ZIJGELEIDING**

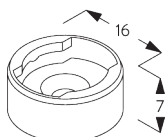
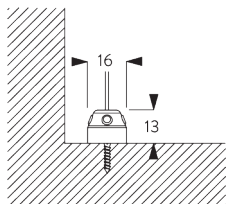

SG 8235

Kabelhouder voor zijgeleiding
kort

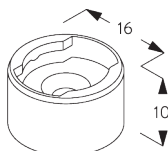

SG 8236

Kabelhouder voor zijgeleiding
lang

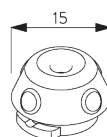

SG 8237

Houder zijgeleiding

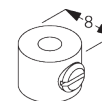

SG 8249

Houder voor zijgeleiding

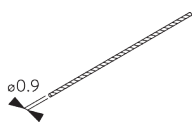

SG 10120

Kabel ø 0.9 mm

SYSTEEMOPTIES

A. BOVENPROFIEL IN DEZELFDE KLEUR

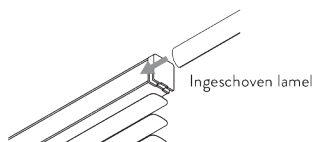

- Een lamel wordt in het bovenprofiel geplaatst voor een perfecte afstemming van kleuren en materialen.
- De hardware wordt geleverd in dezelfde kleur als de lamellen.
- Niet mogelijk met ladderband. Voor lederen jaloeziën is er de optie om het bovenprofiel te bekleden, mits toeslag.

B. ZIJGELEIDING

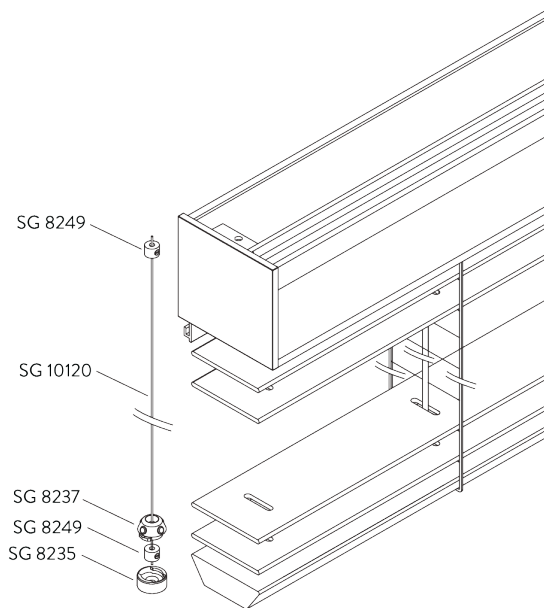

Bijkomende onderdelen:

- 2x SG 8235 Kabelhouder zijgeleiding kort
- 2x SG 8237 Houder zijgeleiding
- 4x SG 8249 Houder zijgeleiding
- 2x SG 10120 Koord 0.9 mm

Notitie:

- Hellingsgraad 15°

MOTOREN EN BESTURINGSMOGELIJKHEDEN

A. KENMERKEN MOTOR

Motoren	SG 11095	SG 11096
Kenmerken		
Soft start / stop	●	●
Ingebouwde ontvanger		●
Elektronische eindstop	●	●
Electronic revolution counter (unlimited revolution)	●	●
Twee tussenposities mogelijk		●
Geruisloze stop	●	●
IP klasse	IP 54	IP 54
Aansturingmogelijkheden		
Netspanningsregeling	●	
SG Control L (met ontvanger)		●
Geschikt voor alle domotica systemen	●	●

B. INFORMATIE

MOTOR

Motoren	Voltage	Ampère	Frequentie	Snelheid	Frequentie ontvanger
SG 11095	230 V AC	0.5 A	50 Hz	35 rpm	n/a
SG 11096	230 V AC	0.5 A	50 Hz	35 rpm	868 MHz

C. BESTURINGS- MOGELIJKHEDEN

Zie catalogus "controles" voor details.

Wandschakelaar



Systeem kan worden bediend met vaste wandschakelaar.

SG Control L



Diverse draadloze hand- en wandzenders beschikbaar.



Silent Gliss Move App.

D. AANSLUIT- SCHEMA'S



Raadpleeg onze Silent Gliss-website.

ONDERDELEN

A. STANDAARD ONDERDELEN



SG 3003

Spanner

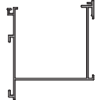

SG 8935

Profiel



SG 8936

Profiel

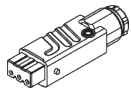

SG 9917

Hirschmann contra stekker

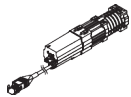

SG 11095

Motor 230V AC, JA 04/35

B. OPTIONELE ONDERDELEN



SG 8235

Kabelhouder voor zijgeleiding kort

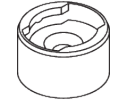

SG 8236

Kabelhouder voor zijgeleiding lang

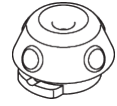

SG 8237

Houder zijgeleiding

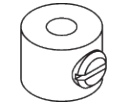

SG 8249

Houder voor zijgeleiding

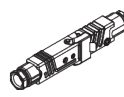

SG 9916

Hirschmann stekkerset



SG 10120

Kabel \varnothing 0.9 mm

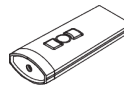

SG 10300

Afstandsbediening, 1 kanaal



SG 10302

Afstandsbediening, 5+1 kanaal



SG 10303

Afstandsbediening, 10+2+1 kanalen



SG 10804

Afstandsbediening 15 kanalen

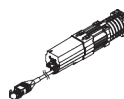

SG 11096

Motor 230V AC, JA 04/35, radio ontvanger



SG 11480

Wandschakelaar 1 kanaal



SG 11490

Wandschakelaar 5+1 kanaal

